

OnCell G4302-LTE4 Series Quick Installation Guide

Moxa OnCell Series

Version 1.0, May 2023

Technical Support Contact Information
www.moxa.com/support

MOXA[®]

© 2023 Moxa Inc. All rights reserved.

P/N: 1802043020010



Overview

The OnCell G4302-LTE4 is a reliable, secure, LTE router with a state-of-the-art LTE module. This 4G cellular router provides a highly reliable connection to your Ethernet and serial network for cellular applications.

The OnCell G4302-LTE4 is ideal for remote-access applications where power consumption needs to be well managed. The power-saving functions help significantly reduce and manage the power consumption of your cellular network. Security functions such as VPN, firewall, NAT, and secure boot protect the internal network from unauthorized access, DoS attacks, and tampering. Wide-temperature support coupled with high levels of EMS protection provides the OnCell G4302-LTE4 with the highest degree of device stability for any rugged environment. In addition, dual-SIM and GuaranLink support help provide network redundancy to ensure uninterrupted connectivity.

The OnCell G4302-LTE4 also comes with a 3-in-1 serial port for serial-over-LTE cellular network communication, making it suitable for collecting and exchanging data with serial/Ethernet devices.

Package Checklist

Before installing your OnCell G4302-LTE4, verify that the package contains the following items. If any of these items is missing or damaged, please contact your customer service representative for assistance.

- 1 OnCell G4302-LTE4 unit
- Quick installation guide (printed)
- Warranty card

Installation and Configuration

You will need access to a notebook computer or PC equipped with an Ethernet port. The OnCell G4302-LTE4 has a default IP address that you must use when connecting to the device for the first time.

Take the following steps to configure your OnCell G4302-LTE4. Refer to the [Panel Layout of the OnCell G4302-LTE4](#) section below for the location of the ports and sockets.

STEP 1: Insert a SIM card and turn on the OnCell G4302-LTE4

1. Install a SIM card into the OnCell device. For details, refer to the [SIM Card Socket](#) section.
2. Turn on the OnCell device by connecting a power terminal block to either or both 12 to 48 VDC power inputs. For details, refer to the [Connecting the Power Input](#) section.

STEP 2: Connect the OnCell G4302-LTE4 to a notebook or PC

Since the OnCell device supports MDI/MDI-X auto-sensing, you can use either a straight-through or crossover cable to connect the OnCell device to a computer. See the [10/100/1000BaseT\(X\) Ethernet Port Connection](#) section for detailed instructions. If the LAN LED indicator on the OnCell device lights up, it means a connection has been established.

STEP 3: Set up an IP address for the computer

Set an IP address on the same subnet as the OnCell device. Since the OnCell device's default IP address is **192.168.127.254**, and the

subnet mask is **255.255.255.0**, you should set the IP address of the computer to **192.168.127.xxx** and the subnet mask to **255.255.255.0**.

STEP 4: Use the web-based manager to configure the OnCell G4302-LTE4

Open your computer's web browser and type **http://192.168.127.254** in the address field to access the homepage of the web-based management system. Before the homepage opens, you will need to enter the username and password. For first-time configuration, enter the following default username and password:

Username: **admin**

Password: **moxa**

Click **Login**.



ATTENTION

For security reasons, we strongly recommend changing the password. To change the password, go to **System → Account Management → User Accounts**, and then follow the on-screen instructions.

Panel Layout of the OnCell G4302-LTE4

Front Panel View

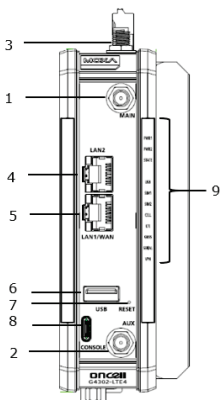

Back Panel View

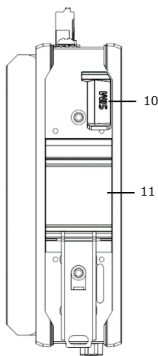

Top Panel View

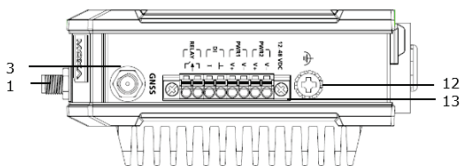

Bottom Panel View

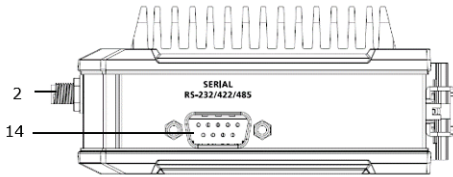

1. Cellular antenna port (Main)
2. Cellular antenna port (AUX)
3. GNSS antenna port
4. 100/1000 Base-T(X) Ethernet LAN port 2 (RJ45)
5. 100/1000 Base-T(X) Ethernet LAN port 1/WAN port (RJ45)
6. USB port
7. Reset button
8. Console port (reserved for engineering use)
9. LED display
10. SIM card tray (SIM1/SIM2)
11. DIN-rail mounting kit
12. Grounding screw
13. Terminal block (PWR1, PWR2, DI, Relay)
14. DB9 serial port

Device Dimensions

Unit: mm (inch)

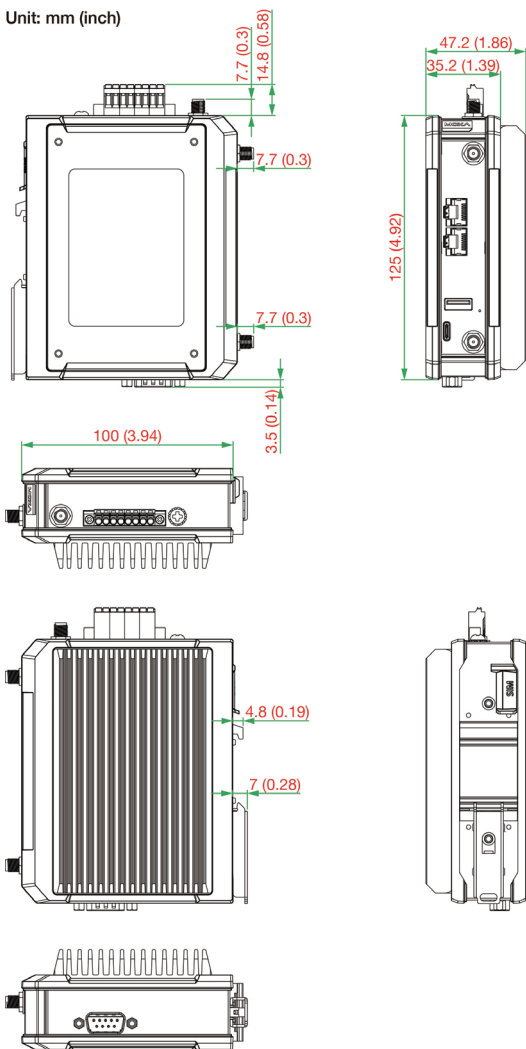

DIN-rail Mounting

The OnCell G4302-LTE4 Series comes with a DIN-rail kit attached to the back panel. Mount the OnCell G4302-LTE4 Series on corrosion-free mounting rails that meet the EN 60715 standard.

Installation

STEP 1: Insert the upper lip of the DIN rail into the top hook of the DIN-rail mounting kit.

STEP 2: Press the OnCell G4302-LTE4 Series towards the DIN rail until it snaps into place.

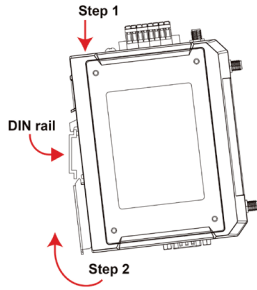

Removal

STEP 1: Pull down the latch on the mounting kit with a screwdriver.

STEP 2: Slightly pull the device forward.

STEP 3: Lift up the device to remove it from the DIN rail.

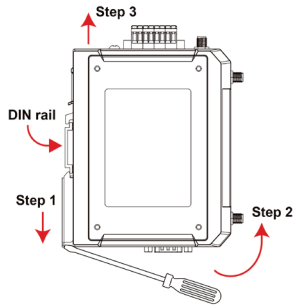

Wall Mounting (optional)

NOTE Mounting the OnCell G4302-LTE4 Series onto a wall requires the WK-41-01 wall-mounting kit, which is sold separately.

For some applications, it may be more convenient to mount the OnCell G4302-LTE4 to a wall, as illustrated below:

Installation

STEP 1: Attach the wall-mounting kit to the OnCell device by inserting the upper lip of the DIN-rail kit into the hook of the wall mounting kit.

STEP 2: Press the OnCell device towards the wall mounting kit until it snaps into place.

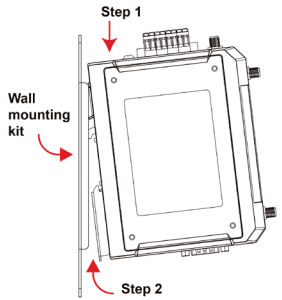

STEP 3:

Mounting the OnCell device to a wall requires 4 screws. Use the OnCell device with the wall mount kit attached as a guide to mark the correct locations of the 4 screws. The heads of the screws should be less than 6.0 mm in diameter, and the shafts should be less than 3.5 mm in diameter, as shown in the figure at the right. The length of the screws should be at least 10 mm.

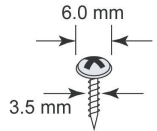

NOTE Test the screw head and shank size by inserting the screws into one of the keyhole shaped apertures of the wall-mounting plates before attaching the plates to the wall.

STEP 4:

Once the screws are fixed into the wall, insert the four screw heads through the large opening of the keyhole-shaped apertures of the mounting kit, and then slide the OnCell device downwards. Tighten the four screws for added stability.

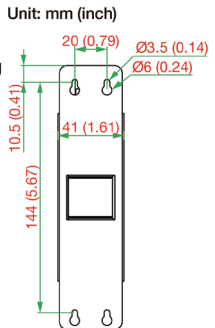

Removal

STEP 1: Pull down the latch on the mounting kit with a screwdriver.

STEP 2: Slightly pull the device forward.

STEP 3: Lift up the device to detach it from the wall.

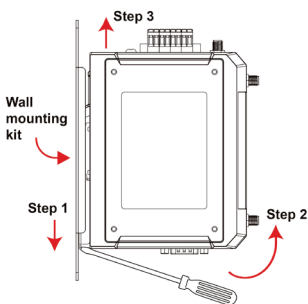

WARNING

- This equipment is intended to be used in a Restricted Access Location, such as a dedicated computer room, where access can only be gained by SERVICE PERSONS or by USERS who have been instructed about the fact that the metal chassis of the equipment is extremely hot and may cause burns.
- Service persons or users should pay special attention and take special precautions before handling this equipment.
- Only authorized, well-trained professionals should be allowed to access the restricted access location. Access should be controlled by the authority responsible for the location with lock and key or a security identity system.
- **External Metal Parts are Hot!!** Pay special attention or use special protection before handling this equipment.

Wiring Requirements



WARNING

Safety First!

Be sure to disconnect the power cord before installing and/or wiring the OnCell device.

Read and Follow These Guidelines

- Use separate paths to route wiring for power and devices. If power wiring and device wiring paths must cross, make sure the wires are perpendicular at the intersection point.

NOTE Do not run signal or communications wiring and power wiring in the same wire conduit. To avoid interference, wires with different signal characteristics should be routed separately.

- You can use the type of signal transmitted through a wire to determine which wires should be kept separate. The rule of thumb is that wiring with similar electrical characteristics can be bundled together.
- Keep input wiring and output wiring separate.
- It is strongly advised that you label wiring to all devices in the system when necessary.



ATTENTION

This product is intended to be supplied by an external power source (UL Listed/ IEC 60950-1/ IEC 62368-1), of which the output complies with ES1/SELV, the output rating is 12 to 48 VDC, 0.96A min., supports an ambient temperature of 70°C minimum for use with OnCell G4302 Series -T models, or an ambient temperature of 55°C minimum for use with OnCell G4302 Series non-T models.

Grounding the Moxa OnCell Series

Grounding and wire routing help limit the effects of noise due to electromagnetic interference (EMI) by routing the noise from the metal chassis to the connected ground. Run the ground connection from the ground screw to the grounding surface prior to connecting devices. The minimum cross-sectional area of the grounding conductor should be equal to that of the input cable. The grounding screw (M4 type) is located near the power connector.



ATTENTION

This product is intended to be mounted on a well-grounded mounting surface, such as a metal panel. The potential difference between the two ground potentials must be zero. If the potential difference is NOT zero, the product could be permanently damaged.

SIM Card Socket

The OnCell G4302-LTE4 comes with two nano-SIM card sockets for cellular communication. The nano-SIM card sockets are located on the back panel protected by a rubber cover.

By default, the SIM card in the SIM1 slot will act as the primary SIM card. To make SIM2 the default SIM, log in to the OnCell's web UI, and configure SIM2 as the primary card. When the OnCell device is turned on, it will boot up based on the configuration information stored on the designated primary SIM card.

Installing a SIM Card

STEP 1: Open the rubber cover.

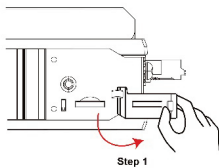

STEP 2: Push the 2-slot SIM card tray to release the tray.

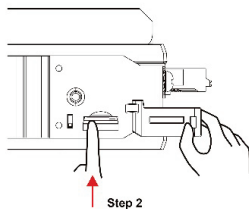

STEP 3: Remove the tray and place the SIM cards into the tray.

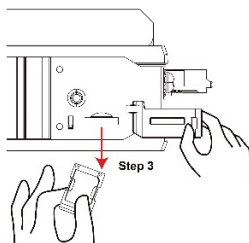

STEP 4: Insert the tray with the SIM cards back into the SIM socket. You will hear a click indicating the tray is locked into place. When inserted, close the rubber cover.

Connecting the Power Input

STEP 1: Use a small flat-blade screwdriver to press the wire locker.

STEP 2: Insert a positive/negative DC wire into the V+/V- terminals respectively.

STEP 3: Release the wire locker and confirm the wire is fixed in place.

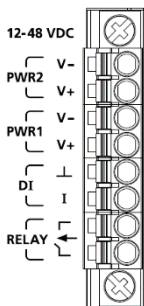

Wiring the Power Input

Top and front views of the terminal block connector are shown below:



ATTENTION

Before connecting the OnCell G4302-LTE4 to the DC power inputs, make sure that the DC power source voltage is stable.

- NOTE**
- The input terminal block wiring should be done by a skilled person.
 - Wire type: Cu
 - Only use 16-20 AWG wire sizes.
 - Each clamping point can only have one conductor.
 - When using a Class I adapter, the power cord should be connected to an outlet with an earthing connection.

Communication Connections

10/100/1000Base-T(X) Ethernet Port Connection

The 10/100/1000Base-T(X) ports located on the front panel of the OnCell device are used to connect to Ethernet-enabled devices.

Pinouts for both MDI (NIC-type) ports and MDI-X (HUB/Switch-type) ports are shown below:

MDI Port Pinouts		MDI-X Port Pinouts	
Pin	Signal	Pin	Signal
1	Tx+	1	Rx+
2	Tx-	2	Rx-
3	Rx+	3	Tx+
6	Rx-	6	Tx-

8-pin RJ45

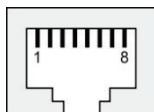

Serial DB9 Connection

The OnCell G4302-LTE4 has one DB9 male port that supports RS-232, RS-485-4W, RS-485-2W, and RS-422. The pin assignments are shown in the table below:

DB9 Male Connector

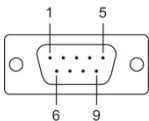

Pin	RS-232	RS-422/485-4w	RS-485-2w
1	DCD	TxD-(A)	-
2	RxD	TxD+(B)	-
3	TxD	RxD+(B)	Data+(B)
4	DTR	RxD-(A)	Data-(A)
5	GND	GND	GND
6	DSR	-	-
7	TRIS	-	-
8	CTS	-	-
9	-	-	-

Console Port

The OnCell G4302-LTE4 Series features a Type-C console port that you can connect to a PC COM port using a Type-C-to-DB9 cable. You can use this port for debugging or firmware upgrades.

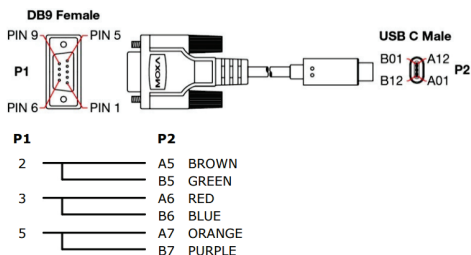

Description	P1	P2
TXD	2	A5, B5
RXD	3	A6, B6
GND	5	A7, B7

USB

The OnCell device is equipped with a type-A USB 2.0 port, which can be used to connect USB storage device or other type-A USB compatible devices.

LED Indicators

The LED indicators are located on the side panel of the OnCell G4302-LTE4. The function of each LED is described in the table below:

LED	Color	Behavior	Function
PWR1	Amber	On	Power is being supplied to power input PWR1.
	Off	Off	Power is not being supplied to the power PWR1.

LED	Color	Behavior	Function
PWR2	Amber	On	Power is being supplied to power input PWR2.
	Off	Off	Power is not being supplied to the power PWR2.
STATE	Green	On	The system passed the self-diagnosis test during boot-up and is ready to run.
		Blinking (1 sec off, 5 sec on)	The system is in Power Saving mode.
	Red	On	The system failed the self-diagnosis test during boot-up.
	Off	Off	The system is off.
USB	Green	On	A USB device is connected.
		Blinking (1 sec off, 1 sec on)	USB data is being transmitted.
	Red	On	The USB device is malfunctioning.
	Off	Off	No USB device connected.
SIM1	Green	On	A SIM card is installed in SIM1 and is working normally.
	Red	On	A SIM card is installed in SIM1 but is not working properly.
	Off	Off	No SIM card installed.
SIM2	Green	On	A SIM card is installed in SIM2 and is working normally.
	Red	On	A SIM card is installed in SIM2 but is not working properly.
	Off	Off	No SIM card installed.
CELL	Green	On	Good cellular signal.
	Amber	On	Fair cellular signal.
	Red	On	Poor cellular signal.
	Off	Off	No cellular signal.
LTE	Green	On	4G LTE connected.
	Amber	On	UMTS/HSPA/GSM/GPRS/EDGE connected.
	Off	Off	No cellular service.
GNSS	Green	On	GNSS located successfully.
	Red	On	Less than 4 satellites located.
	Off	Off	GNSS functionality is disabled.
SERIAL	Green	On	Data is being transmitted over the serial connection.
	Off	Off	No serial connection.
VPN	Green	On	All VPN tunnels are working normally.
	Amber	On	Some VPN tunnels are not working properly.
	Red	On	Failed to establish any VPN connection.
	Off	Off	VPN functionality is disabled.

LED	Color	Behavior	Function
LAN/WAN	Green	On	The port is active, and a link is established at 1000 Mbps.
		Blinking	Data is being transmitted at 1000 Mbps.
	Amber	On	The port is active, and a link is established at 10/100 Mbps.
		Blinking	Data is being transmitted at 10/100 Mbps.
	Off	Off	The port is inactive, or the link is down.

NOTE The LTE LED is designated for the cellular connectivity standard while the CELL LED indicates the cellular signal strength.

Specifications

Input Current	0.96 A (max.)
Input Voltage	12 to 48 VDC
Power Consumption	11.52 W (max.)
Digital input	+13 to + 30 VDC for state 1 -30 to +3 VDC for state 0
Operating Temperature	Standard Models: 0 to 55°C (32 to 131°F) Wide Temp. Models: -30 to 70°C (-22 to 158°F)
Storage Temperature	-40 to 85°C (-40 to 185°F)



ATTENTION

The OnCell G4302-LTE4 is **NOT** a portable mobile device and should be located at least 20 cm away from the human body.

The OnCell G4302-LTE4 is **NOT** designed for the general public. A well-trained technician is required to deploy the OnCell G4302-LTE4 units and safely establish a wireless network.



ATTENTION

Use the antennas correctly!

Wide-band (2G/3G/4G) antennas are needed when the OnCell G4302-LTE4 operates. Make sure that your antenna installation is within a safety area, which is covered by a **lightning protection or surge arrest** system.



ATTENTION

This device complies with part 15 of the FCC Rules. Operation is subject to the following two conditions:

1. This device may not cause harmful interference.
2. This device must accept any interference received, including interference that may cause undesired operation.



ATTENTION

Do not locate the antenna near overhead power lines or other electric light or power circuits, or where it can come into contact with such circuits. When installing the antenna, take extreme care not to come into contact with such circuits, because they may cause serious injury or death when there is a surge. For instructions on proper installation and grounding of the antenna, refer to national and local codes (for example, U.S.: NFPA 70, National Electrical Code, Article 810, and Canada: Canadian Electrical Code, Section 54).



WARNING

EXPLOSION HAZARD!

Do not disconnect equipment unless you have removed the power source to the equipment or the area is known to be non-hazardous.



WARNING

減少電磁波影響，請妥適使用。

本器材須經專業工程人員安裝及設定，始得設置使用，且不得直接販售給一般消費者。

電波功率密度 MPE 標準值 1.0 mW/cm²，送測產品實測值：0.428 mW/cm²，建議使用時設備天線至少距離人體 20 公分。



WARNING

사용자안내문

이 기기는 업무용 환경에서 사용할 목적으로 적합성평가를 받은 기기로서 가정용 환경에서 사용하는 경우 전파간섭의 우려가 있습니다.

기 종별

A 급 기기 (업무용 방송 통신기 자재)

사용자안내문

이 기기는 업무용 (A 급) 전자파 적합 기기로서 판매자 또는 사용자는 이 점을 주의하시기 바라며 가정 외의 지역에서

