

NPort 5400 Series Quick Installation Guide

Version 7.3, April 2021

Technical Support Contact Information
www.moxa.com/support

MOXA[®]

© 2021 Moxa Inc. All rights reserved.

P/N: 1802054000316



Overview

Welcome to Moxa's NPort 5400 Series, a 4 port communication device that allows you to control RS-232 (for NPort 5410), RS-422/485 (for NPort 5430/5430I) or RS-232/422/485 (for NPort 5450/5450I) serial devices over a TCP/IP based Ethernet. Besides, NPort 5450-T and NPort 5450I-T are designed to use in wide temperature environment.

NPort 5400 Series is a Moxa Green Product. Moxa's Green Products satisfy the RoHS directive of the European Parliament, and accordingly, do not contain cadmium and cadmium compounds, hexavalent chromium compounds, lead and lead compounds, mercury and mercury compounds, PBBs (polybrominated biphenyls), or PBDEs (polybrominated diphenyl ethers).

Package Checklist

Before installing NPort 5400, verify that the package contains the following items:

- 1 NPort 5400 4-port Serial Device Server
- Power adapter (Sold separately for the NPort 5450-T and 5450I-T)
- Power jack to 3-pin terminal block adapter
- Wall mount kit
- Quick Installation Guide
- Warranty card

Optional Accessories

- DK-35A For 35 mm DIN-Rail; includes 4 screws

NOTE Notify your sales representative if any of the above items is missing or damaged.

NOTE The operating temperature of the power adapter (if applicable) in the box is from 0 to 40°C. If your application is out of this range, please use a power adapter supplied by UL Listed External Power Supply. (The power output meets SELV and LPS and is rated 12 to 48 VDC; the minimum current is 92.4 mA).

Hardware Introduction

As shown in the following figures, NPort 5410 has 4 Male DB9 ports, for the RS-232 interface, NPort 5430/5430I has 4 5-pin terminal blocks, for the RS-422/485 interface, and NPort 5450/5450I has 4 Male DB9 ports, for the RS-232/422/485 interface.

NPort 5410/5450/5450I

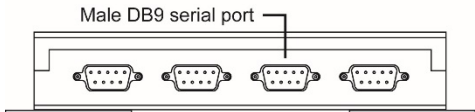
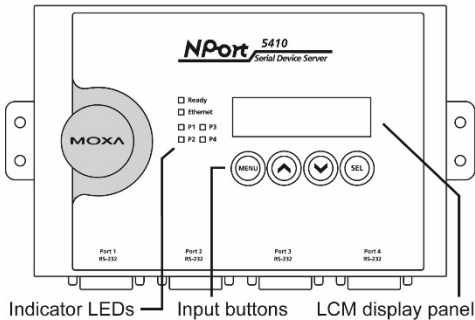
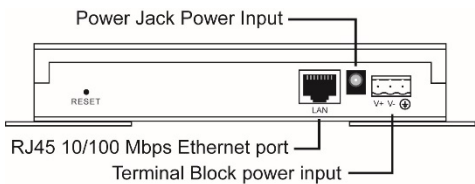

NPort 5430/5430I

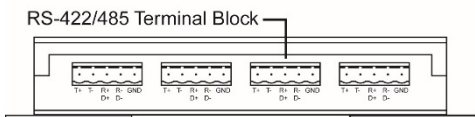
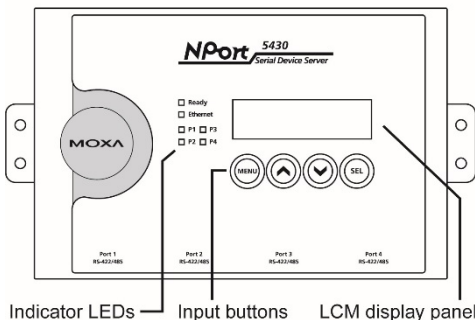
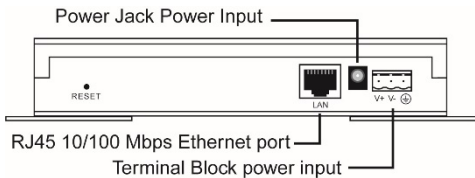

NPort 5450-T/5450I-T

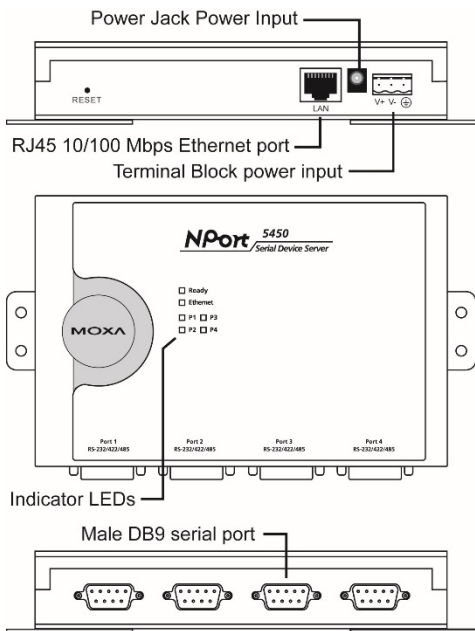

Reset Button—Press the Reset button continuously for 5 sec to load factory defaults: Use a pointed object, such as a straightened paper clip or toothpick, to press the reset button. This will cause the Ready LED to blink on and off. The factory defaults will be loaded once the Ready LED stops blinking (after about 5 seconds). At this point, you should release the reset button.

LED Indicators—NPort 5400's top panel contains six LED indicators, as described in the following table.

LED Name	LED Color	LED Function
Ready	Red	Steady on: Power is on and NPort is booting up. Blinking: Indicates an IP conflict, or DHCP or BOOTP server did not respond properly.
	Green	Steady on: Power is on and NPort is functioning normally. Blinking: The NPort has been located by NPort Administrator's Location function
	Off	Power is off, or power error condition exists.
Ethernet	Orange	10 Mbps Ethernet connection.
	Green	100 Mbps Ethernet connection.
	Off	Ethernet cable is disconnected, or has a short.
P1, P2, P3, P4	Orange	Serial port is receiving data.
	Green	Serial port is transmitting data.
	Off	No data is being transmitted or received through the serial port.

LCM Display Panel (not support in -T model)—When the NPort 5400 unit is powered up, you will see a display similar to:

N	P	5	4	1	0	_	6	1	4	0	5				
1	9	2	.	1	6	8	.	1	2	7	.	2	5	4	

This is where NP5410_61405 is the server's name, and 192.168.127.254 is the server's IP address.

LCM Panel Operation (not support in -T model)—There are four buttons on NPort 5400's top panel used to operate the server's LCM panel. Going from left to right, the buttons are:

Button	Action
MENU	Activates the main menu, or returns to a lower level.
^	Scrolls up through a list of items shown on the LCM panel's second line.
v	Scrolls down through a list of items shown on the LCM panel's second line.
SEL	Selects the option listed on the LCM panel's second line.

Detailed LCM Panel Operating instructions can be found on the CD-ROM in the "NPort 5400 Series User's Manual."

Hardware Installation Procedure

STEP 1: After removing NPort 5400 from the box, the first thing you should do is attach the power adaptor.

STEP 2: Connect NPort 5400 to a network. Use a standard straight-through Ethernet cable to connect to a Hub or Switch. When setting up or testing NPort 5400, you might find it convenient to connect directly to your computer's Ethernet port. In this case, use a cross-over Ethernet cable.

STEP 3: Connect NPort 5400's serial port to a serial device.

STEP 4: Placement Options

Wall or Cabinet Mounting

The NPort 5400 comes with two metal attachment plates for attaching the NPort 5400 to a wall or the inside of a cabinet. First, use two screws per bracket to attach the brackets to the rear of the NPort5400. Next, use two screws per bracket to attach the NPort 5400 to a wall or cabinet.

The heads of the screws should be less than 6.0 mm in diameter, and the shafts should be less than 3.5 mm in diameter, as shown by the figure at the right.

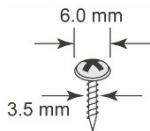

DIN-Rail Mounting

DIN-rail attachments can be purchased separately to attach the product to a DIN-rail. When snapping the attachments to the DIN-rail, make sure that the stiff metal springs are at the top.

Wall Mount

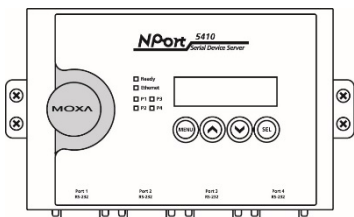

DIN-Rail

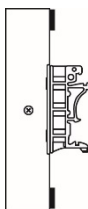

Pull High/low Resistors Setting for the RS-485

Port

DIP switches on the bottom of NPort 5400 are used to set the pull high/low resistor values for each serial port.

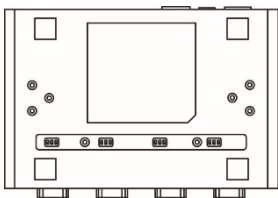

Pull High/low Resistors for the RS-485 Port

SW	1	2	3
		Pull High	Pull Low
ON	1KΩ	1KΩ	120Ω
OFF	150KΩ	150KΩ	-

Default →

NOTE The operating temperature of the power adapter in the box is from 0 to 40°C. If your application is out of this range, please use a power adapter supplied by UL Listed External Power Supply (The power output meets SELV and LPS and rated 12 - 48 VDC, minimum current 0.73 A). Moxa has power adapters with wide temperature range (-40 to 75°C, -40 to 167°F), the PWR-12150-(plug type)-SA-T series, for your reference.

Software Installation Information

For the NPort's configuration, the default IP address of the NPort is: LAN: Static IP = 192.168.127.254; netmask = 255.255.255.0

You may log in with the default account and password (account: **admin**; password: **moxa**) to change any settings to meet your network topology (e.g., IP address) or serial device (e.g., serial parameters). If you would like to apply the Real COM mode to your application, you will need to install NPort's driver on your desktop. You may also refer to Moxa support website <https://www.moxa.com/support/> for the user's manual, driver, the Device Search Utility (DSU), and more.

NOTE For the NPort with DB Male serial ports, you may refer to the DB9 Male Ports pin assignment section to loop back pin 2 and pin 3 for the RS-232 interface to carry out a self test on the device.

Pin Assignments and Cable Wiring

DB9 Male Port Pinouts

Pin assignments apply to NPort 5410 (RS-232 only), 5450, and 5450I.

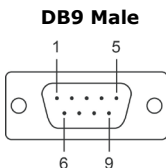

Pin	RS-232	RS-422/ 4-wire RS-485	2-wire RS-485
1	DCD	TxD-(A)	-
2	RxD	TxD+(B)	-
3	TxD	RxD+(B)	Data+(B)
4	DTR	RxD-(A)	Data-(A)
5	GND	GND	GND
6	DSR	-	-
7	RTS	-	-
8	CTS	-	-
9	-	-	-

DB9 Wiring-NPort 5410/5450/5450I

DB9 Female to DB9 Male

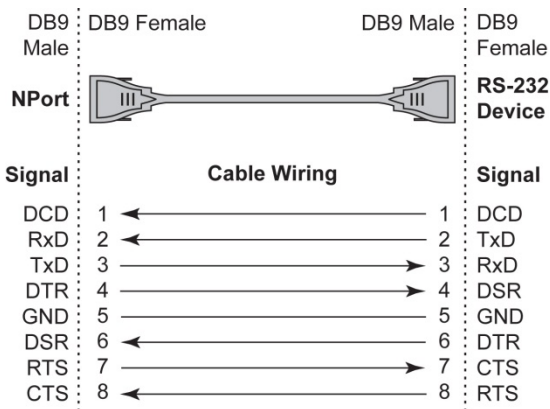

DB9 Female to DB25 Male

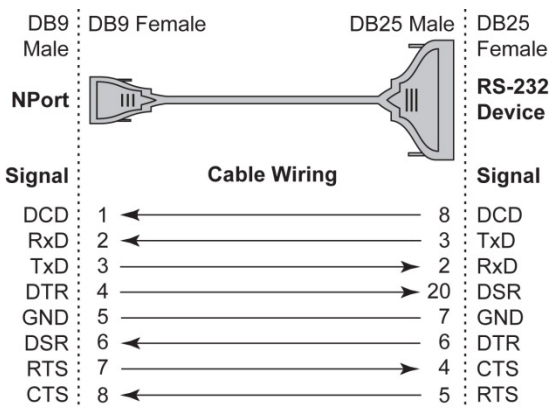

Terminal Block Wiring- NPort 5430/5430I

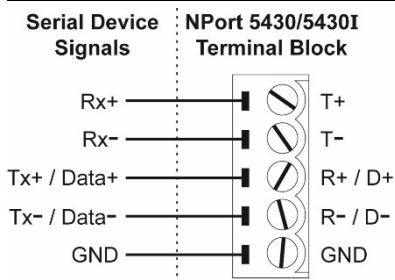

Environmental Specifications

Power requirements	
Input Voltage	12 to 48VDC
Power Consumption:	
NPort 5410	350 mA @ 12 V, 190 mA @ 24 V
NPort 5430	320 mA @ 12 V, 175 mA @ 24 V
NPort 5430I	530 mA @ 12 V, 280 mA @ 24 V
NPort 5450	350 mA @ 12 V, 190 mA @ 24 V
NPort 5450I	554 mA @ 12 V, 294 mA @ 24 V
Operating temp.	
Standard Models	0 to 55°C (32 to 131°F)
Wide Temp. Models	-40 to 75°C (-40 to 167°F)
Operating humidity	5 to 95% RH
Dimensions (W×D×H)	158 × 33 × 103 mm 6.22 × 1.3 × 4.06 in
Serial line protection	Surge: Power: 1 kV; Signal: 1 kV; 2 KV isolation protection (NPort 5430I/5450I models)
Magnetic isolation	1.5 KV for Ethernet
Power line protection	Level 3 Burst (EFT), EN 61000-4-4 Level 3 Surge, EN 61000-4-5
Regulatory approvals	FCC Class A, CE Class A, UL, DNV (for DC input only), LVD, comply to EN 55011: 2007+A2: 2007 Class A (Group 1) and EN 60601-1-2: 2007