

ioThinx 4510 Series User Manual

Version 6.2, July 2024

www.moxa.com/products

MOXA®

© 2024 Moxa Inc. All rights reserved.

ioThinX 4510 Series User Manual

The software described in this manual is furnished under a license agreement and may be used only in accordance with the terms of that agreement.

Copyright Notice

© 2024 Moxa Inc. All rights reserved.

Trademarks

The MOXA logo is a registered trademark of Moxa Inc.
All other trademarks or registered marks in this manual belong to their respective manufacturers.

Disclaimer

- Information in this document is subject to change without notice and does not represent a commitment on the part of Moxa.
- Moxa provides this document as is, without warranty of any kind, either expressed or implied, including, but not limited to, its particular purpose. Moxa reserves the right to make improvements and/or changes to this manual, or to the products and/or the programs described in this manual, at any time.
- Information provided in this manual is intended to be accurate and reliable. However, Moxa assumes no responsibility for its use, or for any infringements on the rights of third parties that may result from its use.
- This product might include unintentional technical or typographical errors. Changes are periodically made to the information herein to correct such errors, and these changes are incorporated into new editions of the publication.

Technical Support Contact Information

www.moxa.com/support

Safety Symbols



DANGER

Shows a high-risk, imminently hazardous situation which, if not avoided, will cause death or serious injury.



WARNING

Shows a moderate risk, which, if not avoided, can cause a potentially hazardous situation.



CAUTION

Shows a low-risk, potentially hazardous situation which, if not avoided, may cause minor or moderate injury.



NOTE

Shows a potential malfunction which, if not avoided, will not result in damage to property.



INFORMATION

This information is important for preventing errors.

Table of Contents

1. Preface	7
Revision History	7
Relevant Models	7
Package Contents	7
Usage Scenarios	8
Hardware and Software Requirements	8
Safety Precautions	9
Additional Resources	10
2. Product Overview	11
Technical Data	11
Common Specifications	11
Appearance	12
Front View	12
Physical Dimensions	13
LED Indicators	14
3. Hardware Installation	15
Wiring System and Field Power	15
System Power	16
Field Power	17
Wiring Ethernet Ports	17
Wiring Serial Port(s)	18
Grounding the Unit	19
Connecting the System Power Ground	19
Connecting the Field Power Ground	20
Mounting the Unit	20
Installing the Unit on a DIN Rail	21
Removing the Unit From a DIN Rail	22
Installing Covers on the Device and the Right-Most I/O Module	23
Removing a Cover from the Right-Most Module	23
Horizontal Installation	24
Powering on the Unit	24
4. Software Tools	25
Preparing Software Tools	25
Connecting Web Console	25
Preparing IOxpress Utility	25
Preparing Moxa CLI Configuration Tool	25
Web Console	26
Dashboard	27
System	30
Security	34
Network	39
Module	40
I/O	42
Serial Port	51
Internal Register	55
Protocol	57
5. Configuring the ioThinX 4510	69
Configuring the Unit	69
Log In to the Unit	69
Configuring Module Settings	70
Changing Device Name	71
Changing the Username and Password	72
Configuring Service Settings	72
Configuring Account Settings	73
Configuring Network Settings	73
Configuring Serial Port and IR Settings	74
Configuring I/O Settings	75
Configuring Modbus Address Settings	75

Configuring SNMP Settings	76
Configuring MQTT Settings	76
Mass-deploying the Settings	77
Updating Configuration to Multiple Units.....	79
Setting Date and Time to Multiple Units	80
Changing IP Addresses to Multiple Devices	81
Changing the Device Name of Multiple Devices	81
Retrieving the System Log From Multiple Devices.....	82
Getting a Self-signed Certificate From Multiple Devices	83
Monitoring and Operating the Unit	83
Monitoring Module & I/O Status	84
Monitoring Connection Status	85
Exiting Safe Mode Status.....	85
Maintaining the Unit.....	86
Backing up Configuration Files	86
Updating the Firmware.....	87
Restarting the Unit	88
Loading Factory Default Settings	89
6. Tutorials	91
How to Use Modbus TCP to Connect to the ioThinX 4510 Series	91
Using Modbus TCP via Modbus Poll	91
How to Use RESTful API to Connect to the ioThinX 4510 Series.....	96
Using RESTful API via Postman	96
Send a GET Request and a PUT Request.....	98
How to Use MQTT to Connect to the ioThinX 4510 Series	100
Broker Settings on the Computer	100
Set Up MQTT on the ioThinX 4510	101
Publisher and Subscriber Settings.....	104
How to Connect ioThinX 4510 to an MQTT Broker over TLS	106
Broker Settings on the Computer	106
Client (publisher) Setting	110
Client (subscriber) setting	110
A. Appendix	111
Network Port Usage	111
Modbus/TCP Slave Rules.....	111
Supported Function Code	111
Exception Code	111
System Registers	111
45MR-1600 (-T), 16 DIs Registers.....	112
45MR-1601 (-T), 16 DIs Registers.....	112
45MR-2404 (-T), 4 Relays Registers	113
45MR-2600 (-T), 16 DOs Registers.....	113
45MR-2601 (-T), 16 DOs Registers.....	114
45MR-2606 (-T), 8 DIs, 8 DOs Registers	114
45MR-3800 (-T), 8 AIs Registers.....	115
45MR-3810 (-T), 8 AIs Registers.....	115
45MR-4420 (-T), 4 AOs Registers.....	116
45MR-6600 (-T), 6 RTDs Registers	116
45MR-6810 (-T), 8 TCs Registers	116
45MR-7210(-T), System and Field Power Input Registers	117
SNMP Rules	117
RESTful API Rules.....	117
Supported Request Method.....	117
GET Request Components	117
PUT Request Components	117
RESTful API List	118
Exception Code	120
MQTT Rules	120
Publish Topic	120
Subscribe Topic.....	123

Troubleshooting.....	124
Forgot Username and Password	124
Forgot IP Address of the Unit.....	124
Failed to Update Firmware.....	125
Failed to Update Configuration	125
Failed to Access the Unit Through IP Address and IOxpress	126
Failed to Enter System Ready Mode.....	126
Import Self-signed Certificate.....	127
System Status and Error Code.....	130

1. Preface

In this chapter, we explain the scope of and how to use this document.

Revision History

Version	Change	Date
v1.0	First Release	2018-11-12
v2.0	<ol style="list-style-type: none">1. Added 45MR-72102. Added MQTT3. Added HTTPS4. Added more mass deploy functions in IOxpress	2019-05-10
v2.1	Added power calculation links	2019-08-22
v3.0	<ol style="list-style-type: none">1. Added 45MR-44202. Added SNMP Trap and Inform	2019-09-11
v4.0	<ol style="list-style-type: none">1. Added SP/FP description2. Added Modbus TCP, RESTful , MQTT tutorial	2020-02-10
v5.0	<ol style="list-style-type: none">1. Change description of HTTPS2. Add LLDP3. Add the system error code4. Change profile information of Modbus RTU5. Update content of Access IP6. Update content of the RESTful API rule	2021-02-25
v6.0	<ol style="list-style-type: none">1. Changed common specifications2. Changed limitation of HTTPS web3. Changed Modbus RTU device profile4. Added remote syslog	2021-11-24
v7.0	<ol style="list-style-type: none">1. Changed the import method of the HTTPS Certificate2. Changed chapter name and content of system error code3. Added SNMP system event alert4. Updated content of Technical Data, Watchdog, Configuration, Security, Internal Register, MQTT, Mass Deploying the Settings, Monitoring Connection Status, Modbus/TCP Slave Rules, SNMP Rules, and RESTful API List	2024-07-26

Relevant Models

This document only applies to the models listed below.

Model Name	Description
ioThinX 4510	Advanced I/O, Ethernet network adapter, 3-in-1 serial port(s), -20 to 60°C operating temperature
ioThinX 4510-T	Advanced I/O, Ethernet network adapter, 3-in-1 serial port(s), -40 to 75°C operating temperature

Package Contents

The following items are included in the product package.

- The ioThinX 4510 device
- Quick installation guide (Printed)
- Warranty card

Usage Scenarios

The ioThinX 4510 Series can be used for the following applications:

1. PLC I/O expansion

The ioThinX 4510 Series can expand the number of I/O points on a PLC.

2. Remote I/O

The ioThinX 4510 Series can be accessed by master software, such as SCADA software, using IT or OT protocols to collect I/O data.

3. Modbus Gateway

The ioThinX 4510 Series has one or more serial ports to connect serial devices. It collects serial data using a Modbus RTU master protocol, which can be accessed by a PLC or master software with IT or OT protocols.

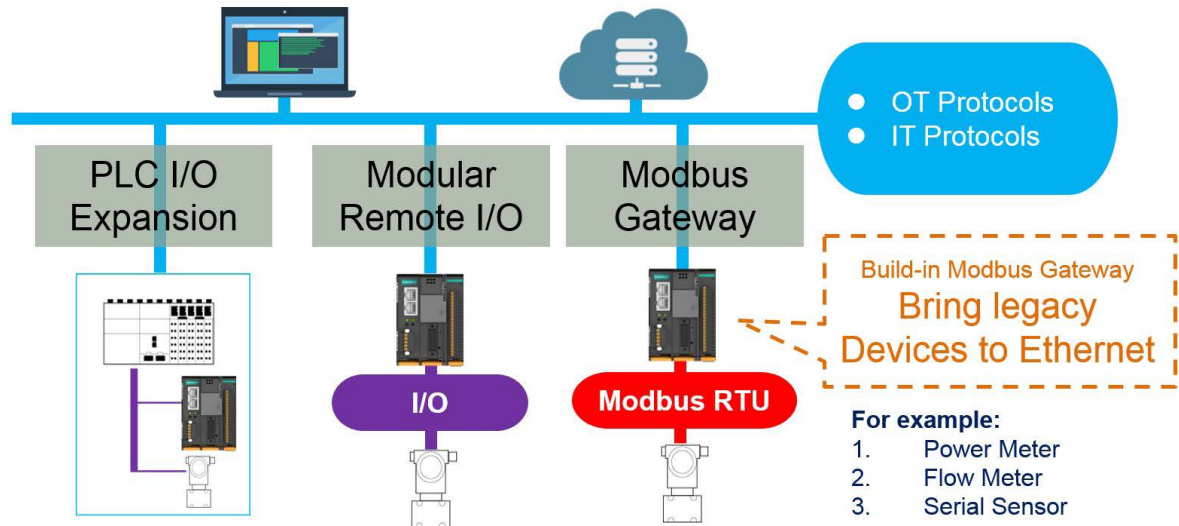

Hardware and Software Requirements

You will need the following hardware and software to use the ioThinX 4510 Series.

- A power source that provides 12 to 48 VDC, and power wires
- A PC running a Windows OS with Chrome installed and an Ethernet cable
- 45MR modules, if available
- IOxpress software utility (optional)
- Moxa CLI Configuration Tool (optional)

Safety Precautions

Please observe the following safety precautions when installing and using the ioThinX 4510 Series:



DANGER

Never work on the device while the power source is switched on. Disconnect all power sources to the device before performing installation, repair, or maintenance work.



DANGER

Disconnect the power when you want to remove or replace components or disconnect equipment unless the area is known to be free of ignitable substances.

- If you connect or disconnect the Removable Terminal Block when field power is applied, an electrical arc can occur. This could cause an explosion when installed in hazardous locations. Ensure that power is removed or the area is nonhazardous before installation.
- If you connect or disconnect wiring while the power is on, an electrical arc can occur. This could cause an explosion in hazardous environments. Ensure that power is removed, or the area is nonhazardous before installation.
- Do not disconnect the unit unless the power has been disconnected or the area is nonhazardous. In a hazardous area, the unit must be powered down before removing it.



WARNING

This unit is sensitive to Electrostatic Discharge, which can cause internal damage and affect operations. Follow these guidelines when you handle this unit:

- Touch a grounded object to discharge potential static.
- Wear an approved grounding wristband.
- Do not touch connectors or pins on component boards.
- Do not touch circuit components inside the equipment.
- Use a static-safe workstation, if available.
- Store the device in the appropriate static-safe packaging when not in use.



WARNING

Check the voltage supplied by the power source. Make sure the voltage provided by the power source matches the voltage required by the device.



WARNING

Check the voltage or current of the sensors or loads. Make sure the voltage and/or current showed on the sensors or loads correspond to the specifications of your 45M module before you connect the device.



WARNING

Connect your device to an earthed ground.



CAUTION

Do not use the device if the device is already damaged. Replace defective or damaged devices to ensure that your devices function properly.



CAUTION

Do not attempt to repair the device yourself. If your device needs to be repaired, return the device to Moxa's customer service department. Attempting to repair the device yourself could invalidate the device's warranty.

Additional Resources

Refer to the following documents for additional information.

- Datasheets for the following products:
 - ioThinx 4510 Series
 - ioThinx 4500 Series (45MR) Modules
- User Manual for the following products:
 - ioThinx 4500 (45MR) Module Series
 - Moxa CLI Configuration Tool

2. Product Overview

In this chapter, we give an overview of each ioThinX 4510 Series device.

Technical Data

Common Specifications

Input/Output Interface

Expansion Slots: Up to 32

Note 1: Compatible with the ioThinX 4500 Series (45MR) Modules only.

Note 2: 8 slots are the maximum when HTTPs web service and two of the following three protocols—SNMP, Modbus TCP, and Modbus RTU—are enabled simultaneously.

Ethernet Interface

10/100BaseT(X) Ports (RJ45 connector): 2, 1 MAC address (Ethernet bypass)

Ethernet Software Features

Industrial Protocols:

Modbus TCP Server (Slave)

Functions supported: 1, 2, 3, 4

Max. number of connections: 7 connections

Note: Maximum connections refer to the number of connections when only Modbus is enabled.

RESTful API

Supported request method: PUT, GET, OPTIONS

Web interface: HTTP, HTTPS

SNMP

Functions supported: SNMP v1/v2c/v3, SNMP v1/v2c/v3 Trap, SNMP v2c/v3 Inform

Max. number of events: 64 events (Inform, Trap or Inform + Trap)

MQTT

Mode: Publisher/Subscriber of MQTT, V3.1.1

QoS level: QoS 0, 1, 2

Secure transmission: TLS (1.2) encryption

Max. number of data tags: 256 data tags

Modbus Serial Interface

Industrial Protocols: Modbus RTU Client (Master)

Connector: Spring-type Euroblock terminal

No. of Ports: 1 x RS-232/422 or 2 x RS-485 (2 wire)

System Power Parameters

Connector: Spring-type Euroblock terminal

Input Voltage: 12 to 48 VDC

Field Power Parameters

Connector: Spring-type Euroblock terminal

Input Voltage: 12/24 VDC

Physical Characteristics

Dimensions: 42.3 x 99 x 75 mm (1.67 x 3.9 x 2.95 in)

Installation: DIN-rail mounting

Wiring:

Serial cable, 16 to 28 AWG

Power cable, 12 to 18 AWG

Environmental Limits

Operating Temperature:

ioThinX 4510: -20 to 60°C (-4 to 140°F)

ioThinX 4510-T: -40 to 75°C (-40 to 167°F)

Appearance

Front View

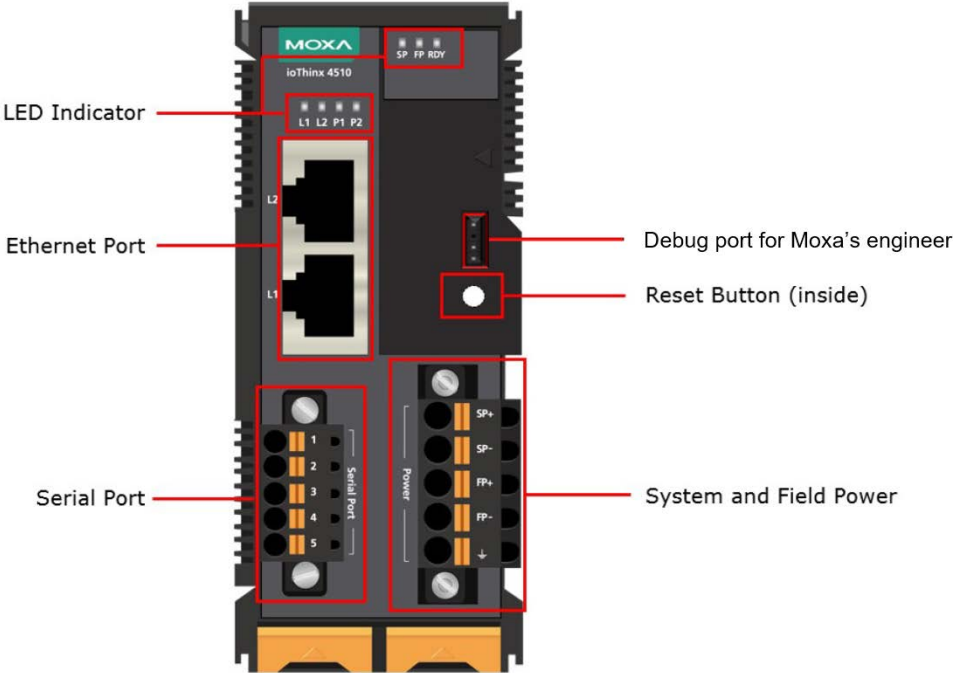

Physical Dimensions

Unit: mm (inch)

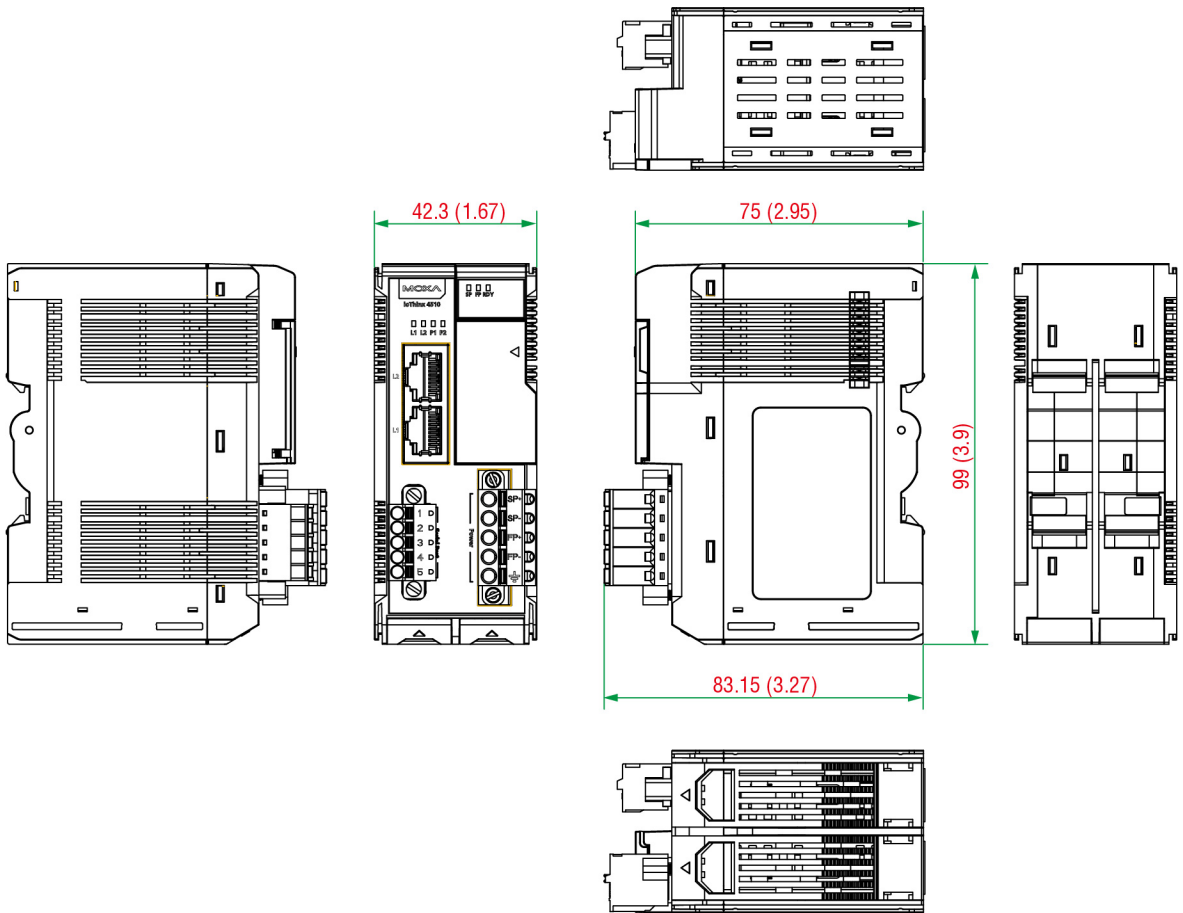

LED Indicators



Labeling	Indication	LED Qty	LED Color	LED Action
SP	System Power	1	Green	On: power on Off: power off
FP	Field Power	1	Green	On: power on Off: power off
RDY	System (Kernel)	1	Green/Red	Green: system ready Green slow blinking: booting up Red: system error or module mismatch Red slow blinking: loading factory default settings, upgrading firmware, or system recovery Red fast blinking: safe mode Off: power off
L1/L2	Ethernet	1 for each	Green/Amber	Green: 100 Mbps Amber: 10 Mbps Blinking: data transmitting Off: disconnected
P1/P2	Serial	1 for each	Green/Amber	Green: Tx Amber: Rx Non-simultaneous blinking: data transmitting Off: disconnected or no data transmitting



NOTE

DO NOT DISCONNECT THE POWER OR NETWORK CABLE when the RDY LED is blinking slowly.



INFORMATION

Refer to [Failed to Enter System Ready Mode](#) in the troubleshooting section for addition information about the system recovery process.

3. Hardware Installation

In this chapter, we describe how to install the ioThinX 4510 Series devices.

Wiring System and Field Power

Wire range: 12 to 18 AWG (ferrule diameter: 2.0 to 1.0 mm)

Wire strip length: 12 to 13 mm

Unit: mm (in.)

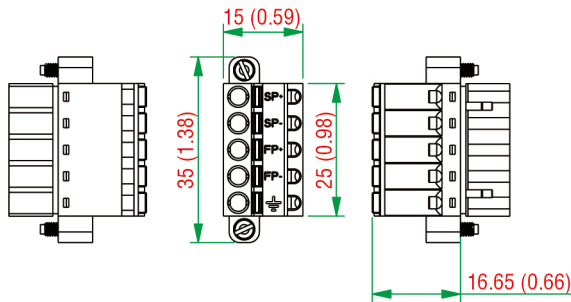

The device requires two sets of power inputs. One is for the system (internal logic circuit), and the other is for field I/O circuits.

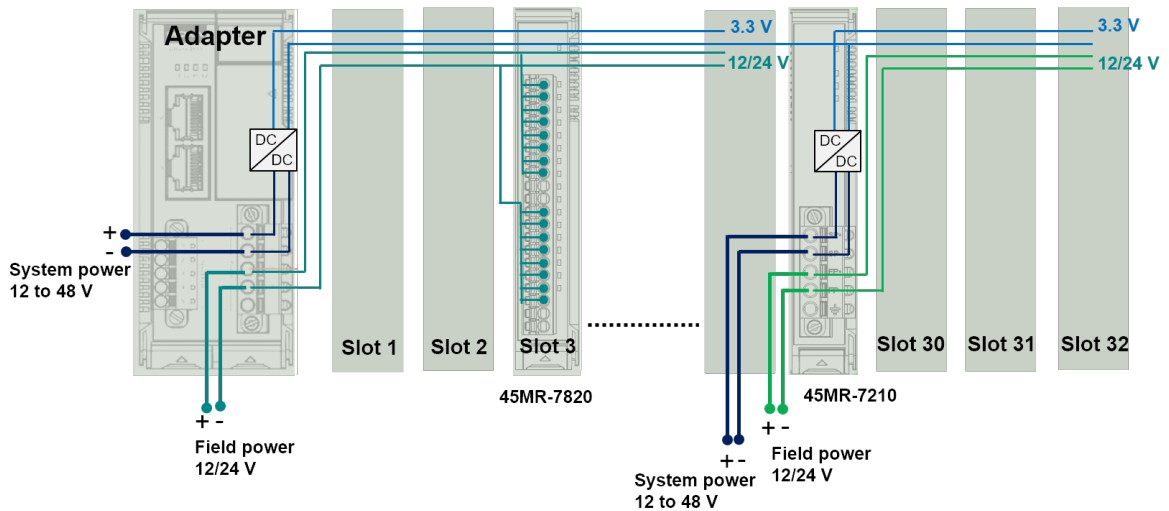

NOTE

All I/O points have 3 kV VDC or 2 kVrms isolation with the system. We recommended using different power supplies to ensure that the system power and field power are isolated from each other.

System Power

This device requires a 12 to 48 VDC system power input. The system power powers this device and the expansion modules via an internal bus, which is galvanically connected to the system power supply.

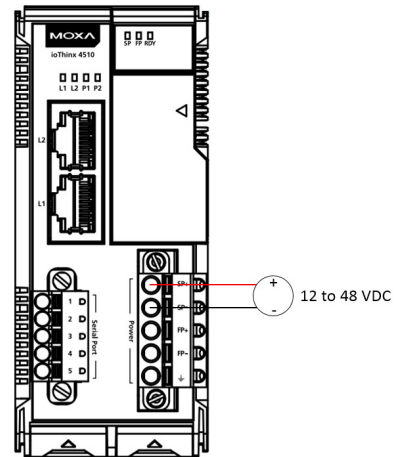

The amount of system current required to support an expansion module is 1 A. If more modules and more power consumption is needed, an additional power module (45MR-7210) is required. Below is an example:

- 10 x 45MR-1600 (59.4 mA) = 594 mA
- 5 x 45MR-3810 (187 mA) = 935 mA

The total system current is 1.594 A, which is greater than 1 A. Therefore, an additional 45MR-7210 is needed.



NOTE

Install the 45MR-7210 to the lefthand side of the module where the power consumption would be exceeded.



NOTE

To avoid damaging your devices, reset all power supplies connected to this device and 45MR-7210 modules at the same time.



NOTE

Click the following link to see how many 45MR-7210 power modules you will need to support your ioThinx 4500 series application: <http://iothinxcalculator.moxa.com>

Field Power

This device provides a field power input of 12/24 VDC that passes directly through the expansion modules and provides a maximum current output of 2 A.

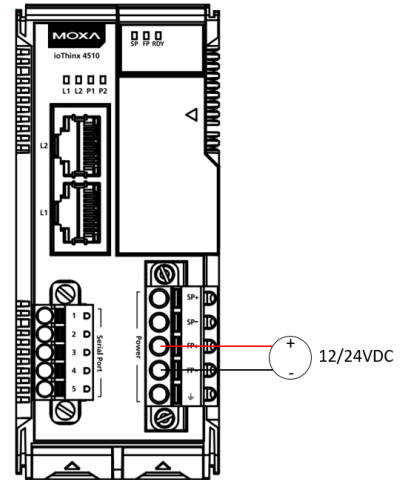

NOTE

The 12/24 VDC field power supply can be connected directly to 45MR modules. If more connection points are needed, purchase 45MR-7820 (8 x FP+ and 8 x FP-) modules.

Wiring Ethernet Ports

The maximum cable length of a 10/100BaseT connection is usually stated as 100 m (350 feet), but the actual limit for your application could be longer or shorter depending on the amount of electrical noise in the environment. To minimize the amount of noise, Ethernet cables should not run parallel to power cables or other types of cables that generate electrical noise. The following diagram and table show the pin assignments for the RJ45 Ethernet ports:

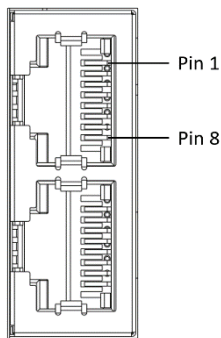

Pin	Media Direct Interface Signal
1	Tx+ (transmit)
2	Tx- (transmit)
3	Rx+ (receive)
4	Not used
5	Not used
6	Rx- (receive)
7	Not used
8	Not used

Wiring Serial Port(s)

Wire range: 16 to 28 AWG
 (Ferrule diameter: 1.2 to 0.3 mm)
 Wire strip length: 9.0 mm

Unit: mm (inch)

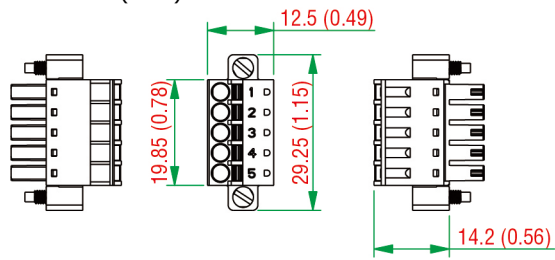

Pin	RS-232	RS-422	RS-485 (P1/P2)
1	TXD	TXD+	DATA1+
2	RXD	TXD-	DATA1-
3	RTS	RXD+	DATA2+
4	CTS	RXD-	DATA2-
5	GND	GND	GND



NOTE

Connect the signal common pin (e.g., GND pin on the serial port pin assignment) between each of the serial device units. For insulated wire (shielding cable) that is used to reduce electrical noise, connect the cable shield drain wire to the chassis ground.



NOTE

To ensure that wires are securely connected to terminal block connectors, strip 7 to 9 mm of insulation off the ends of the wires before connecting them to the terminal block.

Grounding the Unit

This device has two ground pins. One pin is for system power and the other pin is for field power.

Connecting the System Power Ground

The system power ground connector is at the back of the unit. Once the device has been installed on a DIN rail, the system power ground connector will connect to the DIN rail.

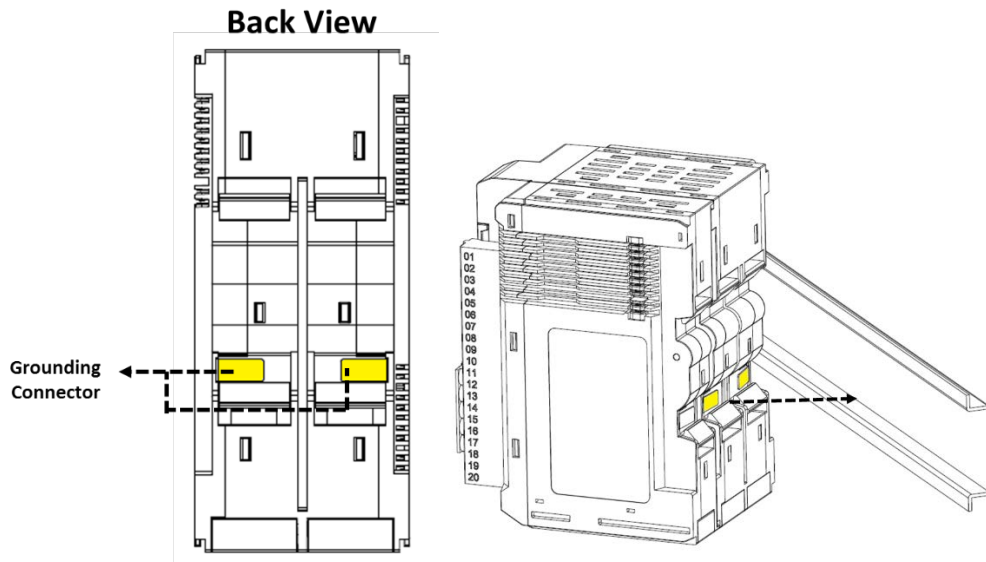

CAUTION

For surge protection, connect the DIN rail to earth ground.

Connecting the Field Power Ground

Connect the field power ground pin (\perp) to your field power ground.

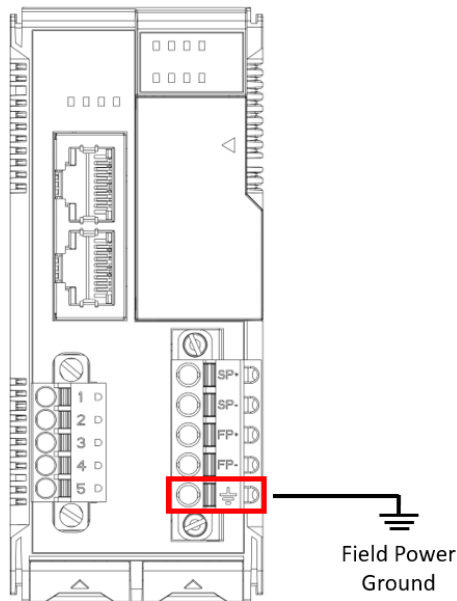

CAUTION

Be sure to note the maximum current for each power wire and common wire. Observe all electrical codes dictating the maximum current allowable for each wire size. If currents exceed the maximum rating, the wires will overheat, which could cause serious damage to your equipment. For safety reasons, we recommend using 2 mm diameter wire to connect to the power supply (e.g., 12 AWG).

Mounting the Unit

In this section, we describe how to mount the device on a DIN rail and how to unmount the device from a DIN rail.



DANGER

Never install the device while the power source is switched on.

Installing the Unit on a DIN Rail

Take the following steps to install the unit on a DIN rail.

Step 1: Hook the mounting clip of the unit onto the DIN rail, and then lower the clip onto the DIN rail. At least 55 mm of space above the DIN rail should be kept free to ensure that the installation can be done correctly.

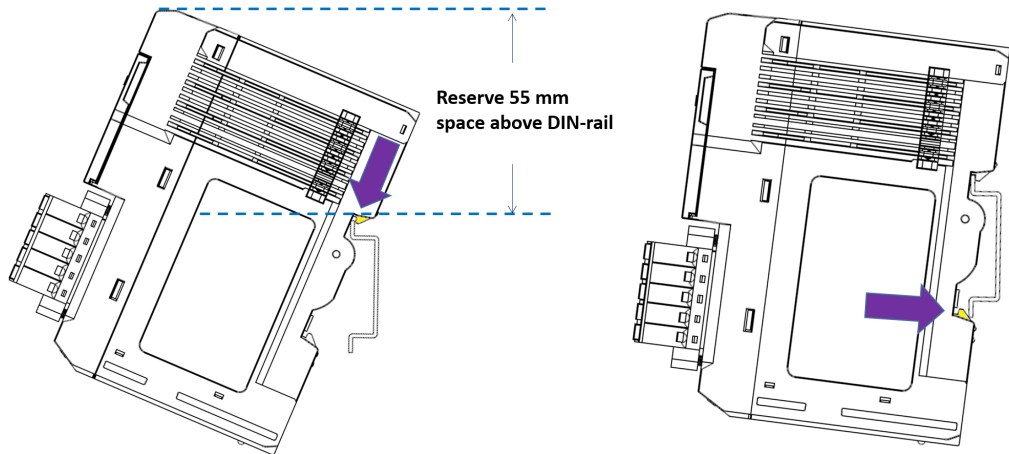

Step 2: Push the unit towards the DIN rail until the end of the mounting clip snaps into place.

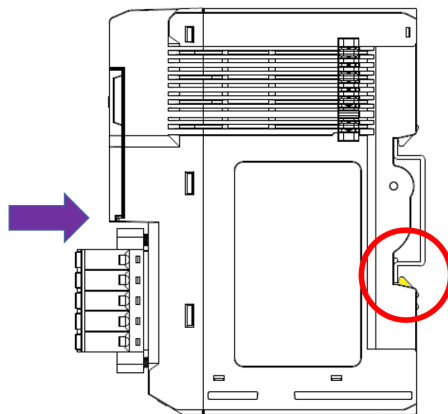

INFORMATION

When the I/O module is inserted into the correct position, the connection between the internal bus and the previous module is established.

Removing the Unit From a DIN Rail

Take the following steps to remove the unit from a DIN rail.

Step 1: Use your finger to pull the release tab on the lower part of the module.

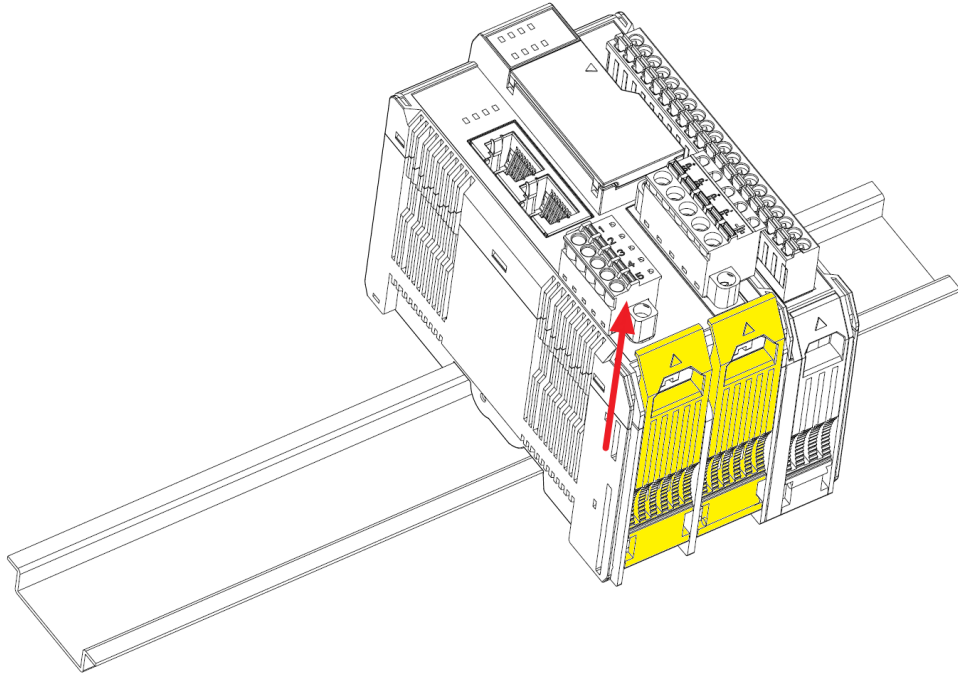

Step 2: Press the release tab (item 1 in the figure) and then remove the CPU module from the DIN rail (item 2 in the figure).

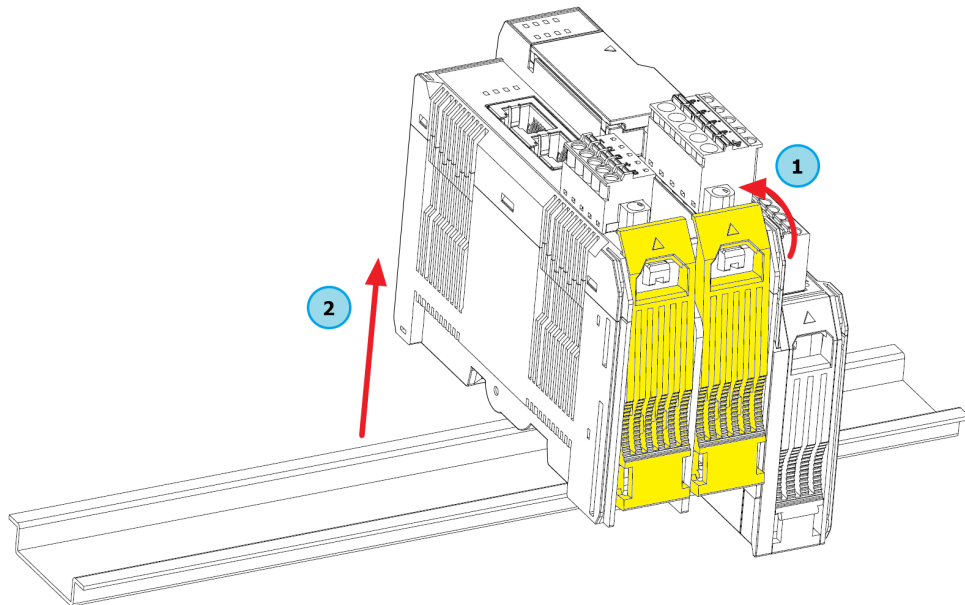

NOTE

Disconnect all connections, including Ethernet, serial, and power cables, from the device before removing the device from the DIN rail.

Installing Covers on the Device and the Right-Most I/O Module

Insert the covers on the left side of the device and on the right side of the I/O module that is installed furthest to the right. Make sure the covers cover the internal bus of the module.

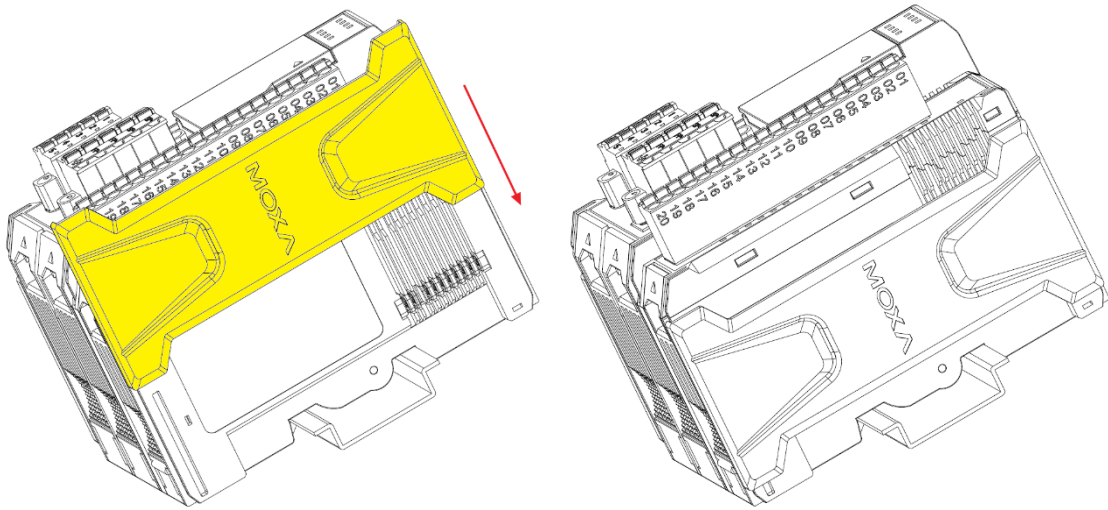

NOTE

The covers provide protection against electrostatic discharge.

Removing a Cover from the Right-Most Module

Before adding a new module to the right-most module, remove the cover first. Place your hand on the cover and slide it up, as shown in the diagram below.

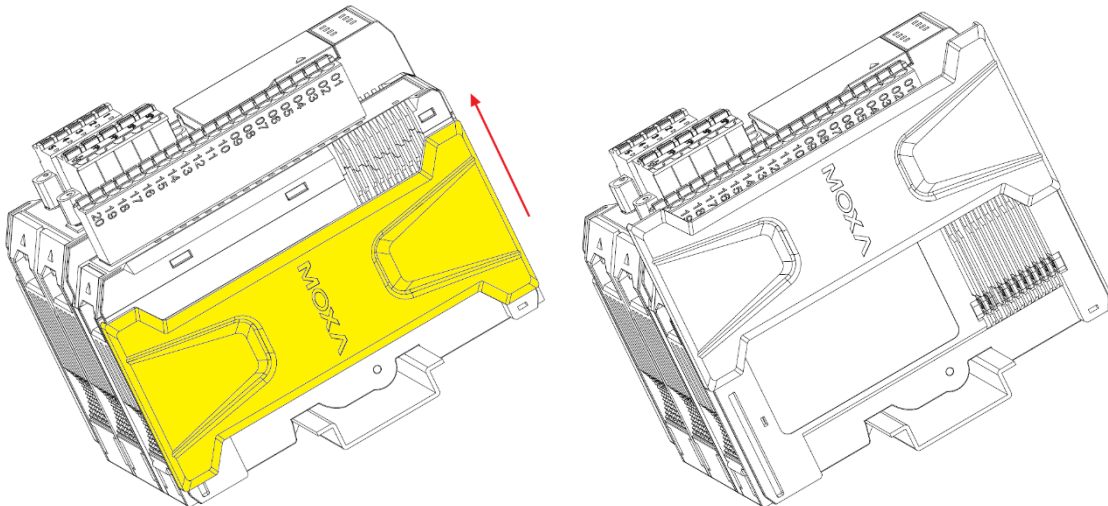

Horizontal Installation

Before installing the device, ensure there is enough space around the device so that it can dissipate heat. In order to ensure the device works properly, we suggest reserving the space shown in the figure below.

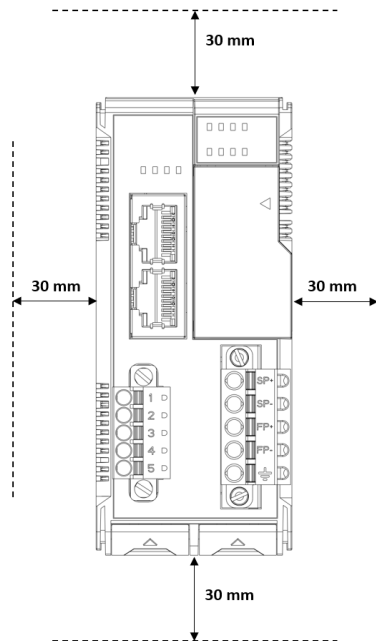

CAUTION

DO NOT install the device vertically, as the fanless heat dissipation design will not perform as intended.

Powering on the Unit

After turning on the power supply, it will take 5 to 10 seconds for the operating system to boot up. The green Ready LED will illuminate continuously until the operating system is ready.

4. Software Tools

In this chapter, we introduce which software tools can be used with this device.

Preparing Software Tools

Connecting Web Console

The Web Console is already embedded in this device. Use the web console to check the device status, configure settings, or update the firmware of the device. Follow the steps below to connect to the web console.

1. Connect the device to your PC through an Ethernet cable.
2. Power on the unit.
3. Open a web browser (Chrome is recommended) on your PC, and type the default IP address shown on the model label of the unit.



INFORMATION

Type in the IP address (if the IP address is not set by default). If the IP address is not available, use the IOxpress utility to search for the device, or load the factory default settings by holding down the RESET button to access the device through the default IP address.

Preparing IOxpress Utility

The IOxpress Utility can be downloaded from the Moxa website at www.moxa.com. After downloading the file, unzip it and run setup.exe. The installation program will guide you through the installation process.

Refer to the [Mass-deploying the Settings](#) section for detailed instructions.



NOTE

The ioThinX 4510 Series is only compatible with IOxpress v2.2 or later.

Preparing Moxa CLI Configuration Tool

Moxa CLI Configuration Tool (MCC_Tool) can be downloaded from the Moxa website at www.moxa.com. After downloading the file, unzip it and run setup.exe. The installation program will guide you through the installation process.

It is a command line tool that provides the following functions to manage field devices.

- Report firmware versions
- Upgrade firmware
- Import/export configuration files
- Change password

Management tasks can be performed according to which devices the user requires (1 for a single device or 1 for multiple devices) and across different subnet networks.

Refer to **Moxa CLI Configuration Tool** User Manual for detailed instructions.

Web Console

The Web Console is the main software tool to configure, monitor, and operate a device. If mass deploying to multiple devices is required, use IOxpress utility instead.

The Web Console is divided into three regions:

1. **Title Panel:** It provides Login, Save & Restart, and Logout functions.
2. **Menu panel:** It provides access to configure the functions or services.
3. **Web page panel:** The web page associated with the function selected in the Menu panel.



INFORMATION

Whenever any configuration is changed, the **Save & Restart** will become red and blink. Click **Save & Restart** to make the changes effective.

Save & Restart | Logout



NOTE

For security reasons, click **Logout** when no longer accessing this device. DO NOT leave the web console unattended.

Dashboard

The dashboard provides information about the system, modules, I/Os, and the connection status. It also allows you to exit the safe mode status or to change the I/O status.

System Information

The one-page system information provides detailed information for this device. For information regarding modules and I/Os, click **Module & I/O** to get the detailed information. For the status of external connections, click **Connection** to get the detailed information.

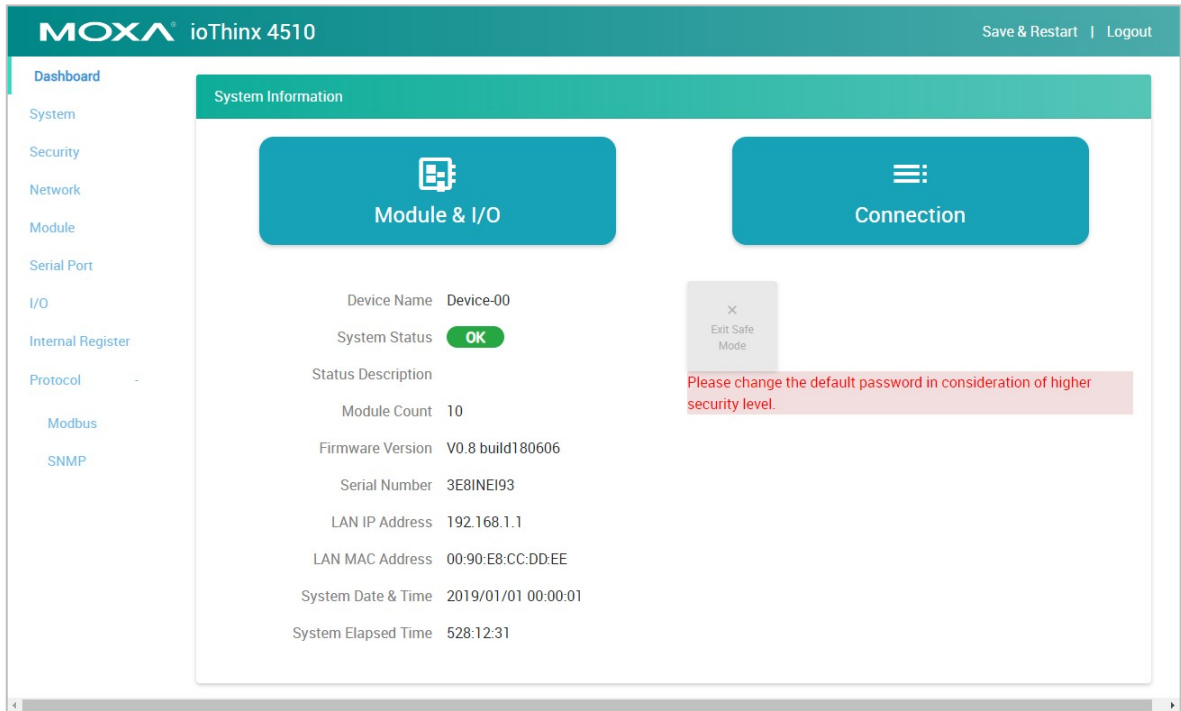

Exit Safe Mode: Manually exit the safe mode status of this device. Refer to the [Security](#) section for more information about the Safe Mode function.

Module and I/O

The **Module & I/O** provides information about modules and I/Os status. It also allows you to change the I/O status.

Module Drop-Down List: It lists all of the I/O modules of this device. Select the specific module for its module and I/O information.

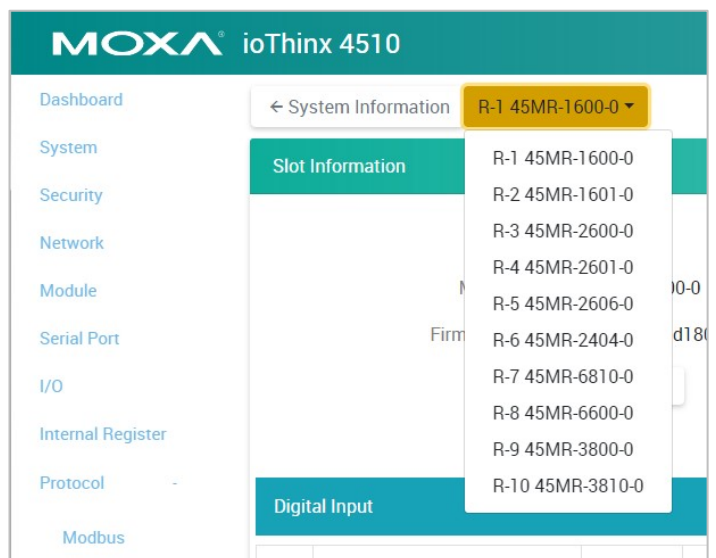

Locate: Identify the physical location of the module and the module's status LED will blink green.

DI Channel (DI Mode): It shows the status of this channel. No operation is allowed.

No.	Name	Mode	Value	Trigger	Filter	Status	Operation
0	DI-00	DI	--	--	500 us	On	--

DI Channel (Counter Mode): It shows the status of this channel. Type a value between 0 and 4294967295, and then click **SET** to set the current counter value. Click **RUN** or **PAUSE** to change the counter status.

No.	Name	Mode	Value	Trigger	Filter	Status	Operation
0	DI-00	Counter	65535	Rising edge	500000 us	Running	65535 SET PAUSE

DO Channel (DO Mode): It shows the status of this channel. Click **ON** or **OFF** to change the DO status.

No.	Name	Mode	ON Width	OFF Width	Pulse Count	Status	Operation
0	DO-00	DO	--	--	--	On	OFF

DO Channel (Pulse Mode): It shows the status of this channel. Click **START** or **STOP** to change the pulse output status.

No.	Name	Mode	ON Width	OFF Width	Pulse Count	Status	Operation
0	DO-00	Pulse	500 us	500 us	10	Start	STOP

Relay Channel: It shows the status of this channel. Click **ON** or **OFF** to change the relay status.

No.	Name	Mode	Status	Operation
0	RELAY-00	Relay	On	OFF

AI Channel: It shows the status of this channel. Click **RESET** to reset the minimum and maximum values.

No.	Name	Scaled Range	Value	Min	Max	Min/Max
0	AI-00	0.000 - 20.000 mA	11.000 mA	8.000 mA	16.000 mA	RESET

AO Channel: It shows the status of this channel. Key in the value and click **SET** to set the output value.

#	Name	Scaled Range	Status	Value	Operation
0	45MR-4420-0@AO-00	4.000 - 20.000 mA	OK	4.000 mA	4.000 SET



NOTE

The AO channel **Status** will change to **Fault** when the channel is open in current mode, when the channel is short in voltage mode, or when field power is not connected.

RTD Channel: It shows the status of this channel. Click **RESET** to reset the minimum and maximum values. Apply the reference temperature value in the calibration field and click **SET** to start the RTD sensor calibration; each calibration requires approximately 30 seconds per channel.

#	Name	Sensor Type	Value	Min	Max	Min/Max	Calibration
0	45MR-6600-0@RTD-00	PT 100	0.000 C	0.000 C	0.025 C	RESET	<input type="text" value="0"/> SET

TC Channel: It shows the status of this channel. Click **RESET** to reset the minimum and maximum values. Apply the reference temperature value in the calibration field and click **SET** to start the TC sensor calibration; each calibration requires approximately 30 seconds per channel.

#	Name	Sensor Type	Value	Min	Max	Min/Max	Calibration
0	45MR-6810-0@TC-00	K TYPE	0.000 C	0.000 C	0.000 C	RESET	<input type="text" value="0"/> SET

SP Channel: It shows the status of this channel. No operation is allowed.

#	Name	Status
0	45MR-7210-0@SP-00	Good

FP Channel: It shows the status of this channel. No operation is allowed.

#	Name	Status
0	45MR-7210-0@FP-00	Under Limit

Connection

The connection page shows the connection status of other hosts. This information can assist you with managing your devices.

The screenshot shows the MOXA ioThinX 4510 web interface. The top navigation bar includes "MOXA ioThinX 4510" and "Save & Restart | Logout". A left sidebar contains navigation links: Dashboard, System, Security, Network, Module, Serial Port, I/O, Internal Register, and Protocol (+). The main content area is titled "System Information" and displays a "Connection List" table.

#	Source Host Address	Type	Port
1	192.168.1.1	Web/Http	80
2	192.168.1.2	SNMP	161
3	192.168.1.3	Modbus TCP Slave	502
4	192.168.1.4	Web/Https	443

System

This section introduces the functions of the device's system.

Device Settings

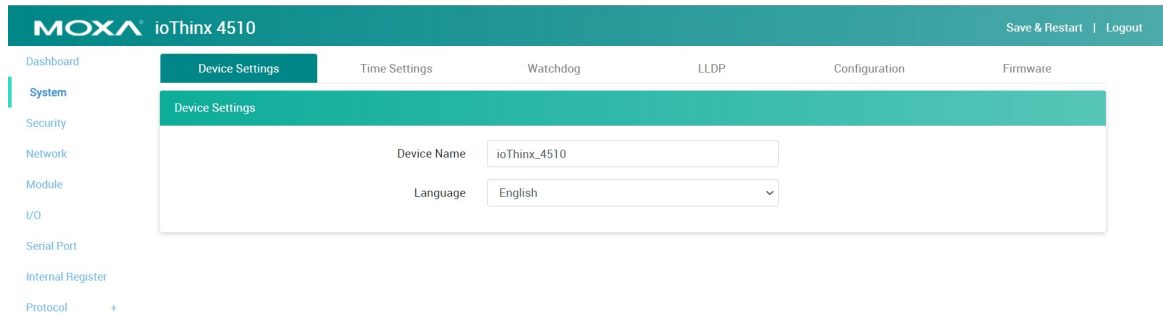

Device Name: Set the name of this device (max length = 16, '.' is not allowed).

Language: Select the language of the web console.

Time Settings

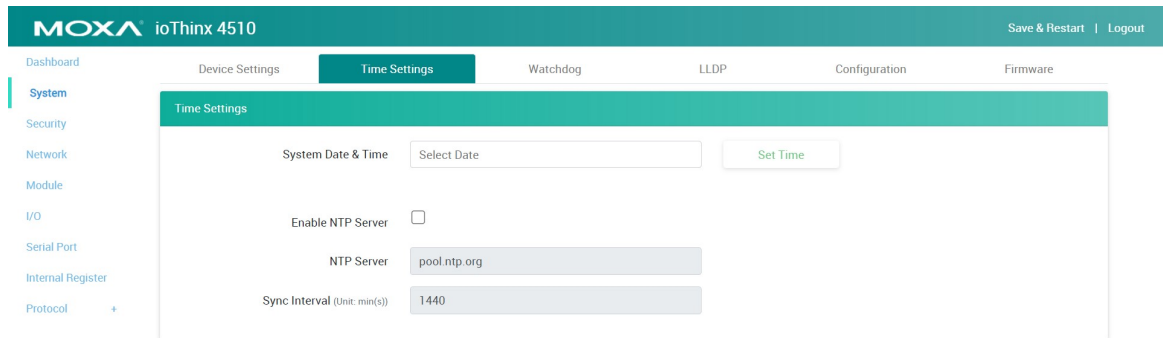

System Date & Time: Select the date for the device. Click **Set Time** to set the time of the device.

Enable NTP Server: Click the checkbox to enable date and time synchronization with the NTP server.

NTP Server: Set the URL or IP address of the NTP server.

Sync Interval: Set the synchronization interval with the NTP sever (unit: min(s), 1 to 43200, default = 1440).



INFORMATION

This device does not have a battery. Therefore, if the device is powered off, the system date and time will have to be set again. If the NTP server is not available, set the date and time of the device after rebooting.

Watchdog

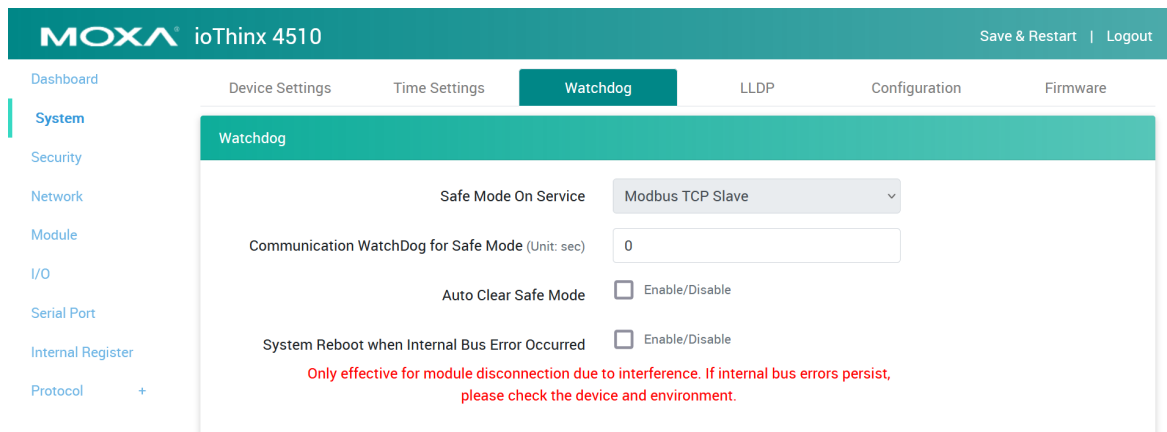

Safe Mode on Service: Select the service that you want to link the watchdog to in order to keep monitoring the connection status (option: Modbus TCP Slave).

Communication Watchdog for Safe Mode: The timeout value when the master of **Safe Mode on Service** is disconnected (unit: sec(s), 0 to 65535, 0 is disabled).

Auto Clear Safe Mode: Click the checkbox to enable or disable automatically clearing the safe mode status.

Once the communication watchdog is timeout, the safe mode will be enabled. The behavior of ioThinx 4510 and 45MR modules are listed below:

	ioThinx 4510	45MR modules
Behavior	<ul style="list-style-type: none"> Wait for Modbus/TCP Master's re-connection Output channels cannot be controlled via any access, e.g., RESTful API or web console 	<ul style="list-style-type: none"> Input channels: no change Output channels: set the channel status according to pre-defined safe mode settings
LED status	RDY: Red fast blinking	Status: Red fast blinking (applied to the modules which have output channels only)

Once the connection is recovered, the behavior of the ioThinx 4510 and 45MR modules are listed below.

1. Auto Clear Safe Mode: Enabled

	ioThinx 4510	45MR modules
Behavior	Recovered to normal status	Recovered to normal status
LED status	RDY: Green	Status: Green

2. Auto Clear Safe Mode: Disabled

	ioThinx 4510	45MR modules
Behavior	Status will remain in safe mode until the safe mode flag is cleared.	Status will remain in safe mode until the safe mode flag is cleared.
LED status	RDY: Red fast blinking until the error flag is cleared manually	Status: Red fast blinking until the error flag is cleared manually

System Reboot When an Internal Bus Error Occurs: Click the checkbox to enable or disable the watchdog feature to monitor the internal bus error activity. When the function is enabled, the ioThinx 4510 will reboot itself when an internal bus error occurs.



NOTE

System Reboot When an Internal Bus Error Occurs only effective for module disconnections caused by interference. If internal bus errors persist, please check the device and the environment.



NOTE

If auto clear safe mode is disabled in the watchdog configuration, once the Modbus connection reconnects, click the **Exit Safe Mode** button on the dashboard or type **0** in the **watchdogAlarmFlagClear** register through Modbus to exit safe mode status. Otherwise, output channels cannot be controlled via any access method, such as RESTful API and web console.

LLDP

The screenshot shows the MOXA ioThinx 4510 web interface. The top navigation bar includes "MOXA ioThinx 4510" and "Save & Restart | Logout". The main menu has "Dashboard", "Device Settings", "Time Settings", "Watchdog", "LLDP", "Configuration", and "Firmware". The left sidebar lists "System", "Security", "Network", "Module", "I/O", "Serial Port", "Internal Register", and "Protocol +". The "LLDP" section is active, displaying a "Service Disabled" status with a note: "Note: enable/disable this service through [Security Service Settings](#)". Below this, the "Message Transmit Interval (Unit: sec)" is set to 5.

Message Transmit Interval: Set up interval time for message transmission via LLDP protocol.

The default status of LLDP is disabled. Please make sure the LLDP service is enabled in the Security Service Settings.

The screenshot shows the MOXA ioThinx 4510 web interface. The top navigation bar includes "MOXA ioThinx 4510" and "Save & Restart | Logout". The main menu has "Dashboard", "Device Settings", "Time Settings", "Watchdog", "LLDP", "Configuration", and "Firmware". The left sidebar lists "System", "Security", "Network", "Module", "I/O", "Serial Port", "Internal Register", and "Protocol +". The "LLDP" section is active, displaying a "Service Enabled" status with a note: "Note: enable/disable this service through [Security Service Settings](#)". Below this, the "Message Transmit Interval (Unit: sec)" is set to 5.

Configuration

Select File: Click **Browse** to select a configuration file to update the device.

Update network settings (IP, Gateway, etc.): Click the checkbox if the network settings need to be updated.

Update to Device: Click **Update** to update the firmware to the device.

Get from Device: Get the configuration file of the device.

Load to Default: Load the factory default settings of the current firmware version.



NOTE

Do not disconnect the power or network cable during the update process.



NOTE

Uploading the config file cannot be done via HTTPS. For those users who have security concerns, we suggest using the manageability utility, IOxpress, to update firmware.



INFORMATION

Back up the configuration file before loading the factory default configurations.

Firmware

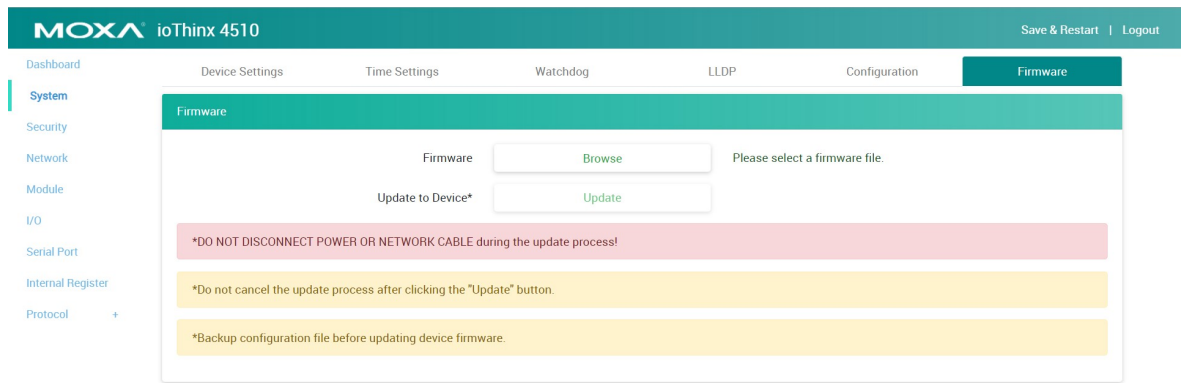

Firmware: Click **Browse** to select a firmware file to update the device.

Update to Device: Click **Update** to update the firmware to the device.



NOTE

Do not disconnect the power or network cable during the update process.



NOTE

This device supports firmware automatic recovery function. If the firmware in the device is corrupted, the system will load the backup firmware automatically to overwrite the corrupted one. When the system is in recovery mode, the RDY LED will slowly blink red. DO NOT DISCONNECT the power cable when the recovery process is underway. After the recovery process is complete, you can update the firmware again.



CAUTION

If you downgrade the device to firmware version v1.0.0, IOxpress will not be able to access the device. In this case, please connect to the device via a web service instead.



INFORMATION

The update process cannot be canceled after "Update" is clicked.



INFORMATION

Back up the configuration file before updating the device firmware.



NOTE

Configurations saved when using v1.0/v1.1 firmware may not be compatible with v1.2 firmware. Please back up the configuration file before upgrading the firmware.

Security

The **Security** section allows you to manage the security policy of the device.



NOTE

Do not expose the device to the public Internet without any security protection. To increase the security of the device, we suggest configuring security settings prior to other settings.

Service Settings

Enable/disable services to prevent unwanted access. The default configuration has Web Server via HTTP and IOxpress/MCC Tool/MXIO enabled.

No.	Service	TCP/UDP	Port
<input checked="" type="checkbox"/> 1	Web Service via HTTP	TCP	80
<input type="checkbox"/> 2	Web Service via HTTPS <small>1. MUST import self-signed certificate before enabling the web service via HTTPS, or the browser may block the connection. 2. The maximum number of 45MR module is eight slots when the HTTPS web service and two of following three protocols (SNMP / Modbus TCP / Modbus RTU), are enabled simultaneously.</small>	TCP	443
<input type="checkbox"/> 3	RESTful API via HTTP	TCP	80
<input type="checkbox"/> 4	RESTful API via HTTPS	TCP	443
<input type="checkbox"/> 5	SNMP Agent/Trap/Inform	UDP	161
<input type="checkbox"/> 6	Modbus/TCP Slave	TCP	502
<input type="checkbox"/> 7	Modbus/RTU Master	-	-
<input type="checkbox"/> 8	MQTT Client	TCP	-
<input type="checkbox"/> 9	LLDP	UDP	-
<input checked="" type="checkbox"/> 10	IOxpress/MCC Tool/MXIO	TCP/UDP	10124/4800

Because of the device limitation, the service combinations vary under different scenarios (HTTP web or HTTPS web).

Please see the use conditions as follows.

	MQTT	Restful API via HTTP, Restful API via HTTPS	SNMP	Modbus TCP	Modbus RTU	LLDP	IOxpress/MCC Tool/MXIO	MXview/MXconfig	Slots of 45MR Module
HTTP Web	One of these three protocols can be used			✓	✓	✓	✓	✓	Up to 32
HTTPS Web	-	-	Two of following three protocols can be used		-	✓	MXconfig only		Up to 8



NOTE

1. If all services are disabled, this device will no longer be accessible, and you will need to load the factory default configurations to access the device.
2. For security reasons, we suggest disabling those services that your application will not use.
3. Before using the web service, import the self-signed certificate via HTTPS. Otherwise, the browser may block the connection.
4. Because of the device limitation, the web console can be accessed via HTTP using any browser, but for HTTPS connections, only the Firefox browser can be used.
5. Because of the device limitation, some services have limitations when HTTPS is enabled.
 - > Eight slots are the maximum slot for the 45MR Module.
 - > The maximum web browser connection is 1.

User Settings

Enable/Disable user type, or configure the username and password for Administrator, Operator, and Users.

MOXA ioThinX 4510 Save & Restart | Logout

Dashboard | Service Settings | **User Settings** | Account Settings | Access Control | Certificate Settings

System
Security
Network
Module
I/O
Serial Port
Internal Register
Protocol +

No.	Type	Username	Permissions
1	Administrator	admin	Full control
2	Operator	operator	Dashboard and I/O status change
3	User	user	Dashboard

Type: Administrator

Enable:

New Username: Must be 1-30 characters. Cannot include spaces, but letters, numbers, and symbols are allowed.

Admin Password:

New Password: Must be 4-16 characters. Letters, numbers, and symbols are allowed. Must include at least one number and one symbol.

Confirm Password:

Type: Select a user type to change the username and password.

Enable: Enable or disable the type you select.

New Username: It allows you to change the username of the selected user type (Must be 1 to 30 characters. Letters, numbers, and symbols are allowed, but not spaces).

Admin Password: Type the password for the administrator to gain authorization to make changes.

New Password: It allows you to change the password of the selected user type (Must be 4 to 16 characters and include at least one number and one symbol. Letters, numbers, and symbols are allowed but spaces are not).

Confirm Password: Type in your new password again.



NOTE

Change the default password in order to enhance security when you first login.



INFORMATION

The default username is admin, and the default password is moxa.

Account Settings

The screenshot displays the 'Account Settings' page for the MOXA ioThinX 4510. The page is organized into a sidebar on the left and a main content area. The sidebar includes sections for 'System', 'Security', 'Network', 'Module', 'I/O', 'Serial Port', 'Internal Register', and 'Protocol'. The main content area is titled 'Account Settings' and contains the following configuration options:

- Idle Timeout (unit: min(s))**: Input field with value 5.
- Retry Failure Threshold (unit: times)**: Input field with value 5.
- Lockout Time (unit: min(s))**: Input field with value 5.
- Login Failure Message**: Text input field.
- System Use Notification**: Text input field.
- Enable Local SysLog**: Checked checkbox.
- Local SysLog**: Includes 'Export' (max: 2000 records) and 'Clear' buttons.
- Enable Remote SysLog**: Unchecked checkbox.
- Remote SysLog Server**: Toggle switch set to 'IP' and input field with value '192.168.127.1'.
- Remote SysLog Facility**: Dropdown menu with value 'local0'.
- Remote SysLog Severity**: Dropdown menu with value 'Information'.

Idle Timeout: The timeout value when the user account is idle (unit: min(s), 0 to 1440 mins, default: 5 mins) Note: 0 for disabled.

Retry Failure Threshold: The maximum number of retries for the user account to log in (unit: time(s), 1 to 10 times, default: 5 times).

Lockout Time: The timeout value for when the user account will be locked because of reaching the retry failure threshold (unit: min(s), 1 to 60 mins, default: 5 mins).

Login Failure Message: Create the message shown on the login webpage after the user account cannot log in (character limit = 200).

System Use Notification: Define the message shown on the login webpage when the user account connects to the Web Console (character limit = 200).

Local SysLog: Users can download the system log by clicking the export button. You can access the most recent 2,000 records. The device will overwrite the oldest data when the memory is full.

Remote SysLog: the ioThinX 4510 can send the system log message to the log server. Each message is labeled with a facility code and is assigned a severity level.

Remote SysLog Server: Choose an IP address or domain name for the remote log server.

Remote SysLog Facility: The remote sysLog facility is one information field associated with a syslog message.

Remote SysLog Severity: Ranked in order of severity, listed from most severe to least severe.

Access Control

Use IP Address/Netmask combinations to control which devices can access the device.

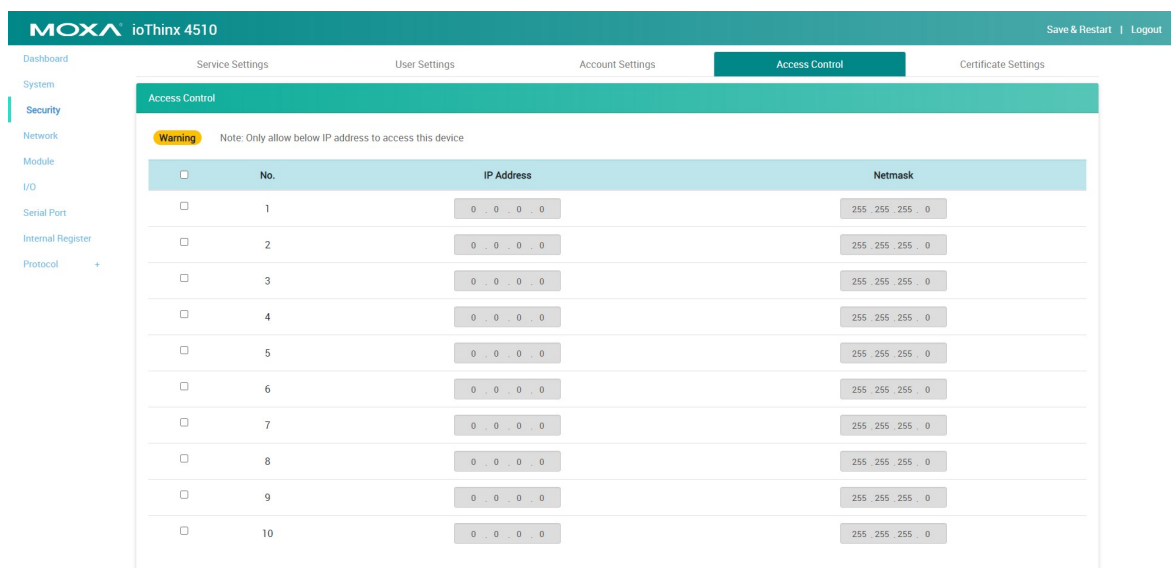

Enable access for a range of IP addresses by specifying the IP address and netmask, as follows:

To allow access to a specific IP address

Enter the IP address in the IP Address field and 255.255.255.255 in the Netmask field.

To allow access for hosts on a specific subnet

Enter 0 as the last digit in both the IP Address field and Netmask field (e.g., 192.168.1.0 and 255.255.255.0).

Refer to the following table for more details about the configuration.

Allowable Hosts	Input Format
192.168.1.120	192.168.1.120/255.255.255.255
192.168.1.1 to 192.168.1.254	192.168.1.0/255.255.255.0
192.168.0.1 to 192.168.255.254	192.168.0.0/255.255.0.0
192.168.1.1 to 192.168.1.126	192.168.1.0/255.255.255.128
192.168.1.129 to 192.168.1.254	192.168.1.128/255.255.255.128

Certificate Settings

The ioThinX 4510 will generate a self-signed certificate based on the IP address. Users can download the certificate by clicking the **Export** button, and then import the certificate through the browser to enhance security.

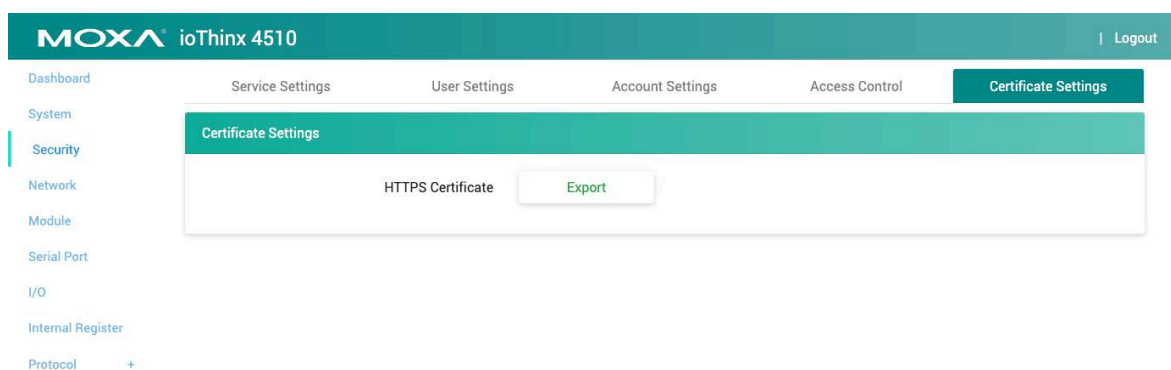

Network

This section introduces the Network settings function.

LAN Settings

The screenshot displays the MOXA ioThinX 4510 web management interface. The top header includes the MOXA logo and 'ioThinX 4510', along with 'Save & Restart' and 'Logout' links. A left sidebar lists navigation categories: Dashboard, System, Security, Network (selected), Module, Serial Port, I/O, Internal Register, and Protocol. The main content area is titled 'LAN Settings' and features a form with the following fields:

IP Configuration	Static IP
IP Address	192 . 168 . 127 . 254
Netmask	255 . 255 . 255 . 0
Gateway	0 . 0 . 0 . 0
DNS1	0 . 0 . 0 . 0
DNS2	0 . 0 . 0 . 0

IP Configuration: Configure the following settings if **Static IP** is selected. If **DHCP** is selected, the following settings are not allowed (option: Static IP or DHCP).

IP Address: Set the IP address of the device (0 to 255).

Netmask: Define the logical subdivision of an IP network and specify the network's available hosts (0 to 255).

Gateway: Define the router that can route the network traffic to the other network or Internet (0 to 255).

DNS1 and DNS2: Define DNS server(s) that can translate URL to IP address (0 to 255).



INFORMATION

The IP address of the device must be unique. Two devices in the network cannot share the same IP address as it causes an IP address conflict.

Module

This section introduces the Module settings function.



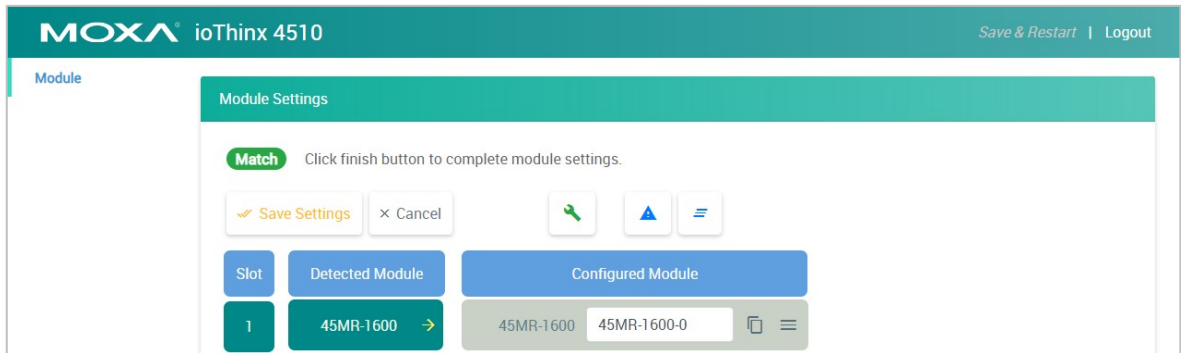

Edit: Click this button to enter edit mode.



Save Settings: This button only appears in edit mode. Click this button to finish module settings and exit edit mode.

Cancel: This button only appears in edit mode. Click this button to cancel module settings and exit edit mode.

Auto Matching : Click this button to automatically match all configured modules with all detected modules.

Load Default : Click this button to load the default settings of all configured modules.

Reload : Click this button to reload the module settings before entering edit mode.

Slot: The slot position of the detected module.

Detected Module: The physical module detected by the system. The yellow arrow allows you to insert the specific module into the configured module.

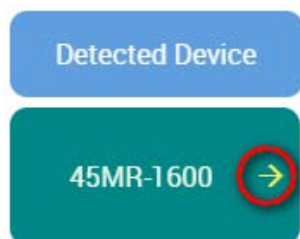

Configured Module: The module settings for the detected module. A unique module name is required in the textbox (max. length = 16, "." character is not allowed).

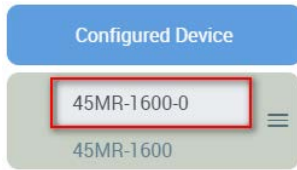

The delete icon appears when you place your mouse over the place indicated below. It allows you to delete the configured module.



The drag icon allows you to drag the configured module and drop it to the position you need.



NOTE

The detected module should match the configured module. Otherwise, the Web Console will not allow you to configure other settings.



NOTE

The detected module should match the configured module. Otherwise, the Web Console will not allow you to click **Finish**.



INFORMATION

Use **Auto Matching** to quickly match the configured module with the detected module.



INFORMATION

Once the setting of a configured module is changed, the configured module will be highlighted by an orange rectangle.





INFORMATION

If the configured module does not match the detected module, the configured module will be highlighted by a red rectangle.

Slot	Detected Device	Configured Device
1	45MR-1600 →	45MR-2600-0 45MR-2600

I/O

This section introduces the I/O and IR (Internal Register) settings functions.

I/O Settings

Module Drop-Down List: It lists all the I/O modules of this device. Select the specific module for I/O configuration.

IO Settings

45MR-1600-0 ▾

- 45MR-1600-0
- 45MR-1601-0
- 45MR-2600-0
- 45MR-2601-0
- 45MR-2606-0
- 45MR-2404-0
- 45MR-6810-0

Digital Input Channel Settings

DI-00

DI ▾

DI-00

Filter (Unit: Counter)

2

Channel Mode Drop-Down List: It lists all of the channel modes, which can be operated by this channel. Select **DI** or **Counter** mode for each channel (option: DI or Counter).

Channel Name: The channel name is used for representing this channel (max. length = 16, "." character is not allowed).



INFORMATION

Every channel in each module must have a different name.

DI Mode

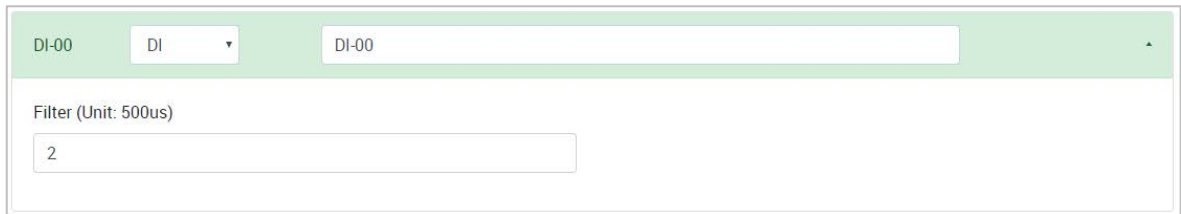

DI-00 DI DI-00

Filter (Unit: 500us)

2

Filter: Software filtering is used to avoid switch bounces (unit: 500 μ s, 0 to 65535).

Counter Mode

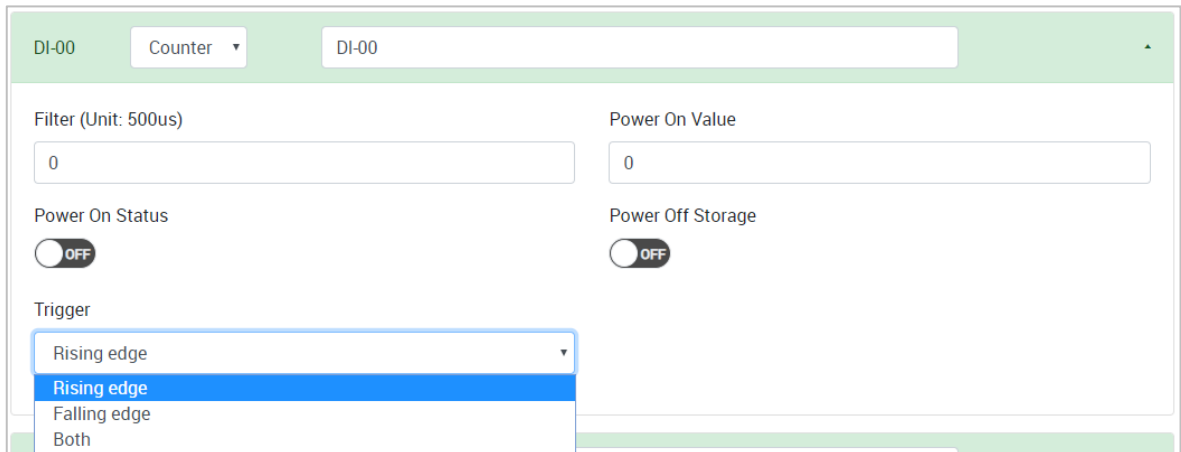

DI-00 Counter DI-00

Filter (Unit: 500us) Power On Value

0 0

Power On Status Power Off Storage

OFF OFF

Trigger

Rising edge

Rising edge

Falling edge

Both

Filter: Software filtering is used to avoid switch bounces (unit: 500 μ s, 0 to 65535).

Power on Value: The initial counter value upon powering up (0 to 4294927695).

Power on Status: The counter status upon powering up (option: ON or OFF).

Power off Storage: Save counter value to memory during powering off. The saved value will be the initial value upon next powering up (option: ON or OFF).

Trigger: The channel accepts limit or proximity switches and counts events according to the ON/OFF status. When **Rising edge** is selected, the counter value increases when the attached switch is pushed. When **Falling edge** is selected, the counter value increases when the switch is released. When **Both** is selected, the counter value increases when the attached switch is pushed or released (option: Rising edge, Falling edge, or Both).



NOTE

Not all DI channels support counter mode. Refer to the **ioThinx 4500 Series (45MR) Modules** datasheet for detailed specifications.

Digital Output Channel Settings

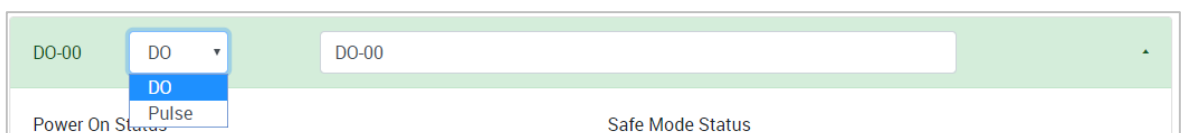

DO-00 DO DO-00

Power On Status Safe Mode Status

Channel Mode Drop-Down List: It lists all of the channel modes, which can be operated by this channel. Select **DO** or **Pulse** mode for each channel (option: DO or Pulse).

Channel Name: The channel name is used for representing this channel (max. length = 16, "." character is not allowed).

DO Mode

DO-00 DO DO-00

Power On Status OFF Safe Mode Status OFF

Power On Delay (Unit: sec)

Power on Status: The DO status upon powering up (option: ON or OFF).

Safe Mode Status: The DO status when the device is in safe mode (option: ON or OFF).

Power on Delay: The time delay before triggering **Power on Status** after powering up (unit: sec(s), 0 to 65535).

Pulse Mode

DO-00 Pulse DO-00

Power On Status OFF Safe Mode Status OFF

Power On Delay (Unit: sec) Pulse Count

ON Width (Unit: 500us) OFF Width (Unit: 500us)

Power on Status: The Pulse status upon powering up (option: ON or OFF).

Safe Mode Status: The Pulse status when the device is in safe mode (option: ON, OFF, or Hold Last).

Power on Delay: The time delay before triggering **Power on Status** after powering up (unit: sec(s), 0 to 65535).

Pulse Count: The number of pulses per triggering (0 to 4294967295, "0" for continuous pulse output).

On Width/Off Width: The high and low level widths of a pulse (unit: 500 μ s, 1 to 65535).

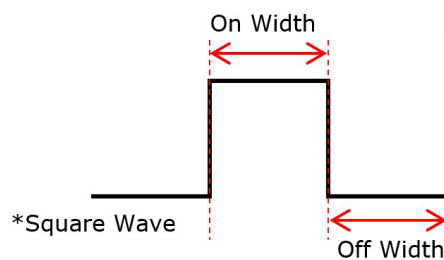

NOTE

Not all DO channels support pulse mode. Refer to the **ioThinX 4500 Series (45MR) Modules** datasheet for detailed specifications.

Relay Channel Settings

Relay-00 Relay RELAY-00

Power On Status Safe Mode Status

OFF OFF

Power On Delay (Unit: sec)

0

Channel Name: The channel name is used for representing this channel (max. length = 16, "." character is not allowed).

Power on Status: The Relay status upon powering up (option: ON or OFF).

Safe Mode Status: The Relay status when the device is in safe mode (option: ON or OFF).

Power on Delay: The time delay before triggering **Power on Status** after powering up (unit: sec(s), 0 to 65535).

Analog Input Channel Settings

Current Module

AI-00 4-20 mA burnout AI-00

Measured Max Value Unit

Voltage Module

AI-00 0-10 V AI-00

Measured Max Value Unit

Channel Mode Drop-Down List: It lists all of the channel modes, which can be operated by this channel. Select **0-20 mA**, **4-20 mA burnout**, or **4-20 mA** mode for each channel of the current module. Select **0-10 V** or **±10 V** mode for each channel of the voltage module.

Channel Name: The channel name is used for representing this channel (max. length = 16, "." character is not allowed).

Disable Mode

AI-07 4-20 mA burnout AI-07

0-20 mA

4-20 mA burnout

4-20mA

Disable

The AI channel can be disabled. It only allows you to disable channels one-by-one. When a channel has been disabled, the sample rate of the remaining channels will be increased automatically.

0-20 mA/4-20 mA burnout/4-20 mA/0-10 V/±10 V Mode

AI-00 4-20 mA burnout AI-00

Burnout Value (Unit: mA)

1st Point Measured Value

2nd Point Measured Value

Unit

1st Point Scaled Value

2nd Point Scaled Value

Scaled Unit

Burnout Value (only for 4-20 mA burnout mode): The 4–20 mA burnout mode is shown in the diagram below.

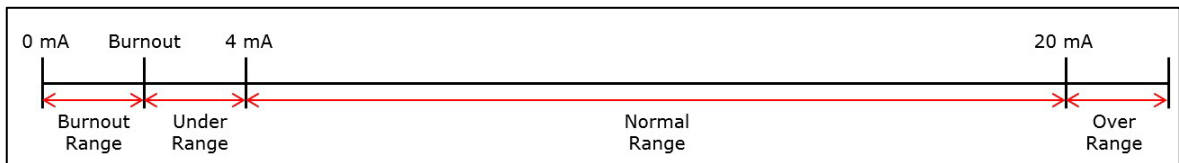

The Burnout Value (default = 2 mA) is definable (unit: mA, 0.000 to 4.000). When input values are in the burnout range, raw data will register as 0000h to show that the analog input has burned out. The definition of raw data can be found in the table below.

Range	Modbus Data
$0.000 \leq AI < \text{Burnout Value}$	0x0000h
$\text{Burnout Value} \leq AI \leq 20.000 \text{ mA}$	Raw Data
$AI > 20.000 \text{ mA}$	0xFFFFh

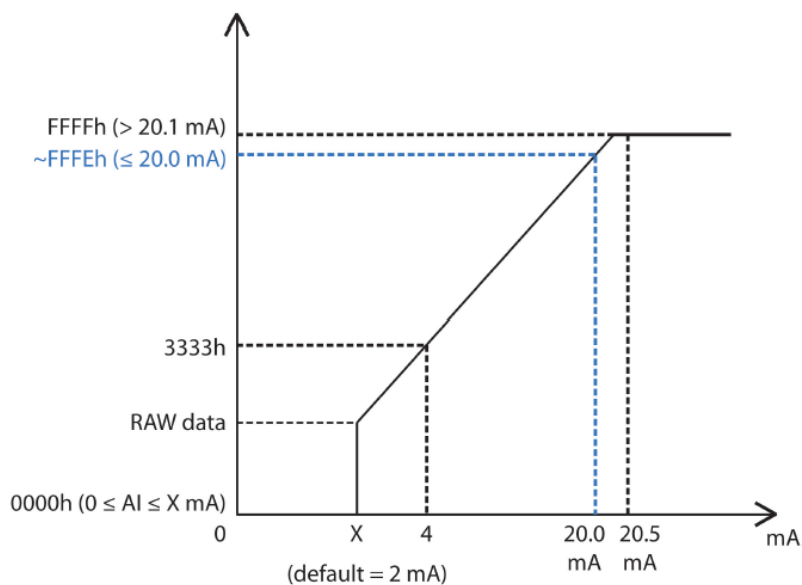

1st Point Measured Value: The 1st point value in the range of channel mode to be scaled to the **1st Point Scaled Value** (unit: mA, 4.000 to 20.000).

2nd Point Measured Value: The 2nd point value in the range of channel mode to be scaled to the **2nd Point Scaled Value** (unit: mA, 4.000 to 20.000).

Unit: The unit of the measured value.

1st Point Scaled Value: The scaled value of the 1st point (-4294967295 to 4294967295).

2nd Point Scaled Value: The scaled value of the 2nd point (-4294967295 to 4294967295).

Scaled Unit: The unit of the scaled value (max. length = 8, "." character is not allowed).

Analog Output Channel Settings

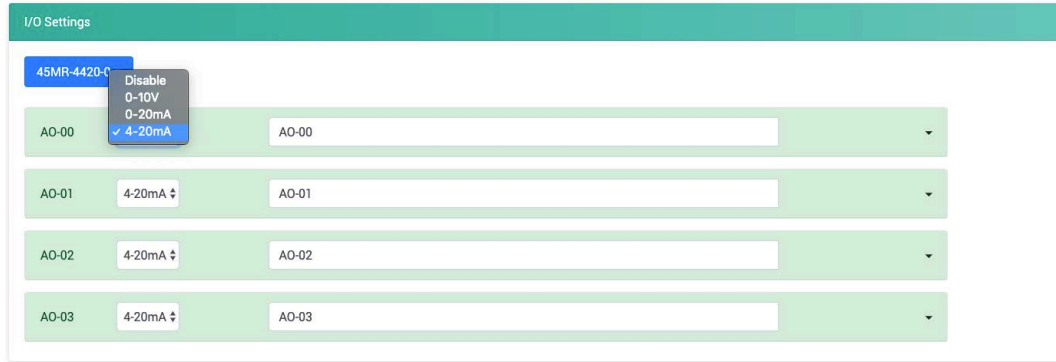

Channel Mode Drop-down List: It lists all of the channel modes which can be operated by this channel. Select **Disable**, **0-10 V**, **0-20 mA**, or **4-20 mA** for each channel.

Channel Name: The channel name is used to represent this channel (max. length = 16, "." character is not allowed).

Disable Mode



Disable the AO channel. Channels must be disabled one-by-one.

0-10 V/0-20 mA/4-20 mA Mode

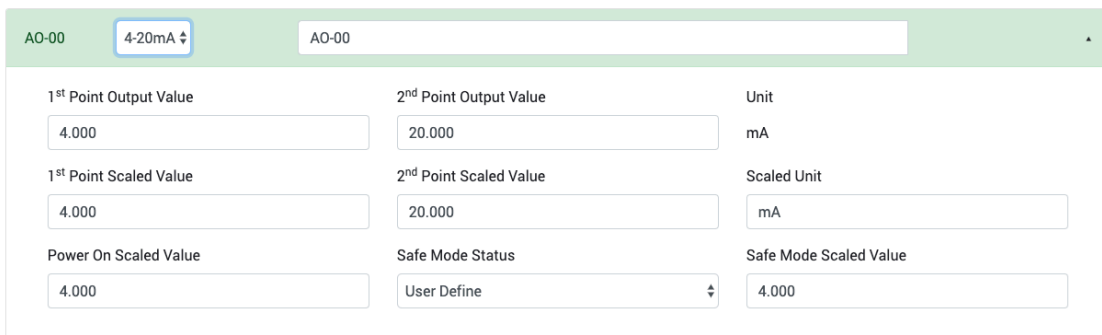

1st Point Output Value: The 1st point value in the range of channel mode to be scaled to the **1st Point Scaled Value** (range: 0-20 mA mode: 0.000 to 20.000, 4-20 mA mode: 4.000 to 20.000, 0-10V mode: 0.000 to 10.000).

2nd Point Output Value: The 2nd point value in the range of channel mode to be scaled to the **2nd Point Scaled Value** (range: 0-20 mA mode: 0.000 to 20.000, 4-20 mA mode: 4.000 to 20.000, 0-10V mode: 0.000 to 10.000).

Unit: The unit of the output value.

1st Point Scaled Value: The scaled value of the 1st point (range: -4294967295 to 4294967295).

2nd Point Scaled Value: The scaled value of the 2nd point (range: -4294967295 to 4294967295).

Scaled Unit: The unit of the scaled value (max. length = 8, "." character is not allowed).

Power On Scaled Value: The AO scaled value upon powering on.

Safe Mode Status: There are two options for defining the safe mode value: **User Define** and **Hold Last**.

Safe Mode Value: The safe mode AO scaled value when the Safe Mode Status is set to User Define.

RTD Channel Settings

RTD-00	PT100	RTD-00
RTD-01	PT100	RTD-01
RTD-02	PT100	RTD-02
RTD-03	PT100	RTD-03
RTD-04	PT100	RTD-04
RTD-05	PT100	RTD-05

Sensor Type Drop-Down List: It lists all the sensor types that can be connected to this channel. Select the sensor type for each channel (option: PT50, PT100, PT200, PT500, PT1000, 310 ohms, 620 ohms, 1250 ohms, 2200 ohms, JPT100, JPT200, JPT500, JPT1000, NI100, NI200, NI500, NI1000, NI120, or Disable).

Disable Mode

I/O Settings

45MR-6600-0

RTD-00	PT 100	RTD-00
RTD-01	PT 100	RTD-01
RTD-02	PT 100	RTD-02
RTD-03	PT 100	RTD-03
RTD-04	PT 100	RTD-04
RTD-05	PT 100	RTD-05

The RTD channel can be disabled. You may only disable channels one-by-one. When a channel has been disabled, the sample rate of the remaining channels will be increased automatically.

Channel Name: The channel name is used for representing this channel (max. length = 16, "." character is not allowed).

RTD-00	PT 100	RTD-00
1 st Point Measured Value	2 nd Point Measured Value	Unit
-200.000	850.000	C
1 st Point Scaled Value	2 nd Point Scaled Value	Scaled Unit
-200.000	850.000	C

1st Point Measured Value: The 1st point value in the range of channel mode to be scaled to the **1st Point Scaled Value** (acceptable input value depends on the type of sensor).

2nd Point Measured Value: The 2nd point value in the range of channel mode to be scaled to the **2nd Point Scaled Value** (acceptable input value depends on the type of sensor).

Unit: The unit of the measured value.

1st Point Scaled Value: The scaled value of the 1st point (-4294967295 to 4294967295).

2nd Point Scaled Value: The scaled value of the 2nd point (-4294967295 to 4294967295).

Scaled Unit: The unit of the scaled value (max. length = 8, "." character is not allowed).

TC Channel Settings

TC-00	K Type	TC-00
TC-01	J Type	TC-01
TC-02	K Type	TC-02
TC-03	T Type	TC-03
	E Type	
	R Type	
	S Type	
	B Type	
	N Type	
	±78.126 mV	
	±39.062 mV	
	±19.532 mV	

Sensor Type Drop-Down List: It lists all the sensor types that can be connected to this channel. Select the sensor type for each channel (option: J Type, K Type, T Type, E Type, R Type, S Type, B Type, N Type, ±19.532 mV, ±39.062 mV, ±78.126 mV, or Disable).

Disable Mode

The screenshot shows the 'I/O Settings' page for a device with model '45MR-6810-0'. It displays a list of eight TC channels, labeled TC-00 through TC-07. Each channel has a dropdown menu for sensor type and a text input for the channel name. A dropdown menu is open for TC-00, showing options: J TYPE, K TYPE (checked), T TYPE, E TYPE, R TYPE, S TYPE, B TYPE, N TYPE, ±78.126mV, ±39.062mV, ±19.532mV, and Disable. The channel names are currently set to TC-00 through TC-07.

The TC channel can be disabled. You may only disable channels one-by-one. When a channel has been disabled, the sample rate of the remaining channels will be increased automatically.

Channel Name: The channel name is used for representing this channel (max. length = 16, "." character is not allowed).

The screenshot shows the detailed configuration for TC-00. At the top, it shows 'TC-00', 'K TYPE', and 'TC-00'. Below this are two rows of input fields:

1 st Point Measured Value	2 nd Point Measured Value	Unit
-200.000	1250.000	C
1 st Point Scaled Value	2 nd Point Scaled Value	Scaled Unit
-200.000	1250.000	C

1st Point Measured Value: The 1st point value in the range of the channel mode to be scaled to the **1st Point Scaled Value** (acceptable input value depends on the type of sensor).

2nd Point Measured Value: The 2nd point value in the range of the channel mode to be scaled to the **2nd Point Scaled Value** (acceptable input value depends on the type of sensor).

Unit: The unit of the measured value.

1st Point Scaled Value: The scaled value of the 1st point (-4294967295 to 4294967295).

2nd Point Scaled Value: The scaled value of the 2nd point (-4294967295 to 4294967295).

Scaled Unit: The unit of the scaled value (max. length = 8, "." character is not allowed).

System Power (SP) channel Setting

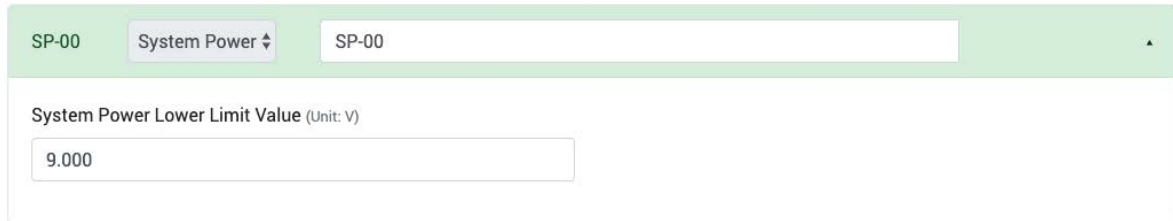

SP-00 System Power SP-00

System Power Lower Limit Value (Unit: V)

9.000

Channel Name: The channel name is used for representing this channel (max. length = 16, "." character is not allowed).

System Power Lower Limit Value: When the system power voltage drops below the limit, the system power alarm will be triggered.

Field Power (FP) channel Setting



FP-00 Field Power FP-00

Channel Name: The channel name (FP-00) is used to represent this channel (max. length = 16, "." character is not allowed).

Serial Port

This section introduces the serial port settings function.

The ioThinx 4510 serial port only supports Modbus RTU master in southbound communications. The retrieved data and/or the exception code from the Modbus RTU slave will be stored in the ioThinx 4510's internal register.

Three steps are required to complete the serial port settings:

- Port Setting
- Device Setting
- New Profile Setting

Port 1/Port 2

Click the tab to configure the settings of Port 1 or Port 2.



NOTE

The Port 2 tab is only available when the **Mode** of the Port 1 is **RS-485 2-Wire**.

The screenshot shows the MOXA ioThinx 4510 web interface. The top navigation bar includes 'Save & Restart' and 'Logout'. The left sidebar lists various system settings. The main content area is titled 'Port 1' and 'Port Settings'. The settings are as follows:

Setting	Value
Mode	RS-485 2-Wire
Baudrate	9600
Parity	NONE
Data Bits	8
Stop Bits	1
Flow Control	None

Mode: The standard of the serial device connected to this port (option: RS-232, RS-422, or RS-485 2-Wire).

Baudrate: The data transmission rate (option: 300, 1200, 2400, 4800, 9600, 19200, 38400, 57600, or 115200 bps).

Parity: The method of detecting errors in transmission (option: Even, Odd, or None).

Data Bits: The data bits in each character (option: 5, 6, 7, or 8).

Stop Bits: The stop bits sent at the end of every character (option: 1 or 2).

Flow Control: The handshaking method (option: None, RTC/CTS, or XON/XOFF).

Modbus RTU Device

The screenshot shows the 'ModbusRTUDev_1' device settings page. The page is titled 'Device Setting' and includes the following configuration options:

- Enable Device
- Device Name: ModbusRTUDev_1
- Device ID: 1
- Advanced:
- Delay between Polls (Unit: 100ms): 10
- Polling Timeout (Unit: 100ms): 30
- Polling Retries: 3

Device Drop-Down List: It shows the device name of the Modbus RTU devices. Select one device to configure its settings. The green icon shows that data collection from the device is enabled.

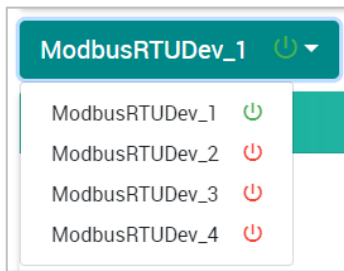

Enable Device: Click the checkbox to enable data collection from the device. The icon beside the Modbus device in the **Device Drop-Down List** will change from red to green after being enabled.

Device Name: Name of the Modbus device (max. length = 16; "." character is not allowed).

Device ID: The device ID of this Modbus device (options: 1 to 247; default: 1).

Advanced Button: Click this button to show/hide the following settings.

Delay between Polls: The delay time after polling the Modbus register(s) of the Modbus device (unit: 100 ms; 100 to 3600000; 0 disabled; default: 10).

Polling Timeout: The timeout value when polling data from the Modbus device (unit: 100 ms; 0 to 30000; default: 30).

Polling Retries: The maximum number of retries after a polling timeout occurs (options: 0 to 10; default: 3).



NOTE

A maximum of four Modbus RTU devices can be connected to one serial port when the RS-485 mode is selected.

Modbus RTU Device Profile

Click **Add New Profile** to create a profile of the selected device.

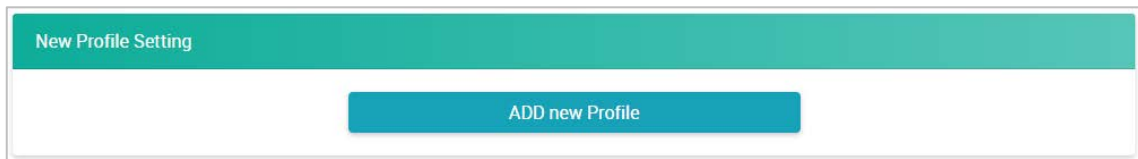

The image shows a dialog box titled "New Profile Setting". It has a teal header bar with the title. Below the header, there is a white area containing a single teal button labeled "ADD new Profile".

After creating a new profile, configure the settings of the profile.

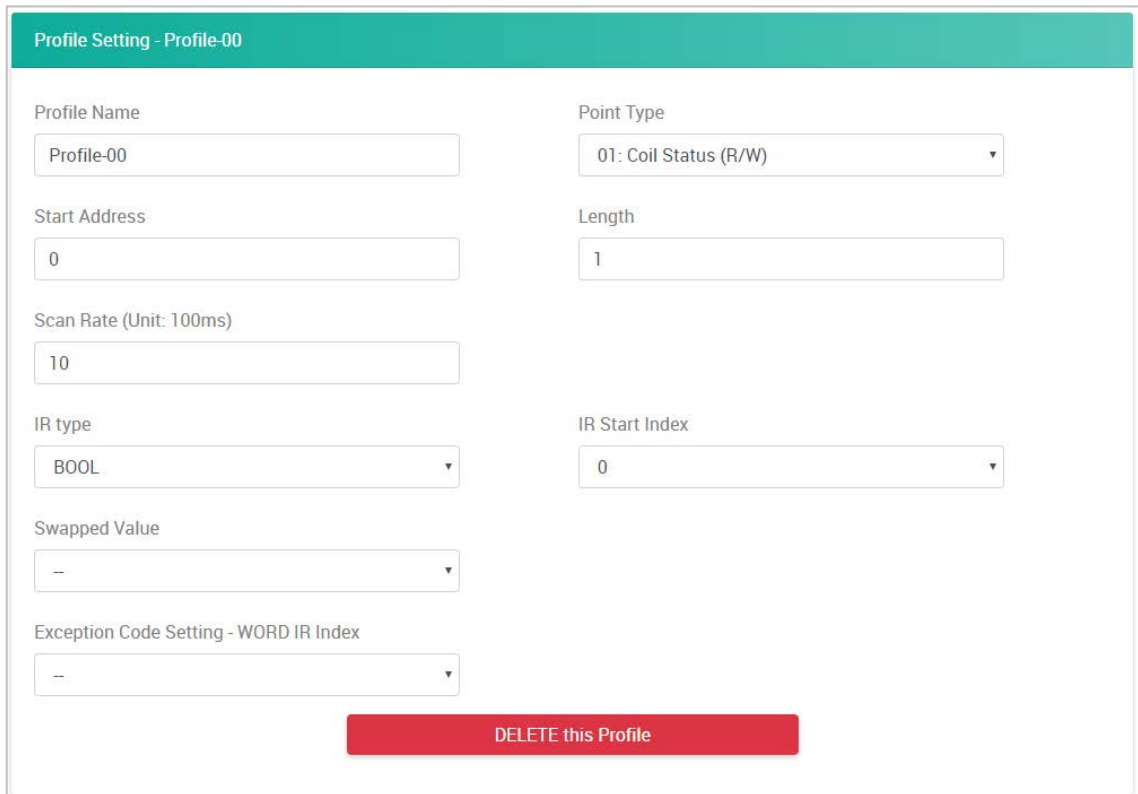

The image shows a configuration form titled "Profile Setting - Profile-00". It has a teal header bar with the title. The form contains several input fields and dropdown menus arranged in two columns. At the bottom, there is a red button labeled "DELETE this Profile".

Profile Name	Point Type
<input type="text" value="Profile-00"/>	<input type="text" value="01: Coil Status (R/W)"/>
Start Address	Length
<input type="text" value="0"/>	<input type="text" value="1"/>
Scan Rate (Unit: 100ms)	
<input type="text" value="10"/>	
IR type	IR Start Index
<input type="text" value="BOOL"/>	<input type="text" value="0"/>
Swapped Value	
<input type="text" value="--"/>	
Exception Code Setting - WORD IR Index	
<input type="text" value="--"/>	

Profile Name: Name the profile of the Modbus device (max. length = 16; "." character is not allowed).

Point Type: Set the corresponding Modbus point type setting (option: 01: Coil Status (R/W), 02: Input Status (R), 03: Holding Register (R/W), or 04: Input Register (R))

Start Address: Define the start address of this Modbus tag (0 to 65535).

Length: Define the length of the coil (1 to 48) or the register (1 to 48).

Scan Rate: Define how quickly to poll the profile data (unit: 100 ms; 100 to 3600000; default: 10).

IR Type: Set the internal register data type (option: BOOL, WORD, DWORD, FLOAT, UWORD, or UDWORD).

IR Start Index: Set the start number of the internal register for storing data. It only allows you to select available internal registers, depending on the length you define.

Swapped Value: Select a data conversion option.

IR Type	Option
WORD	Byte swap
DWORD	1. Word swap and byte swap 2. Byte swap 3. Word swap
FLOAT	1. Word swap and byte swap 2. Byte swap 3. Word swap
UWORD	Byte Swap
UDWORD	1. Word swap and byte swap 2. Byte swap 3. Word swap

Exception Code Setting - WORD IR Index: Set the internal register for exception code. It only allows you to select one of the available internal registers.

Delete this Profile: Click this button to delete this profile.



NOTE

The maximum number of Modbus RTU device profiles that can be created is as follows.

1. RS 232: 1 serial port/1 device/4 profiles.
2. RS 422: 1 serial port/4 devices/16 profiles.
3. RS 485: 2 serial port/8 devices/32 profiles.



NOTE

The UWORD and UDWORD are available from the v1.4 firmware and later versions.

Internal Register

This section introduces functions of Internal Register settings.

The Internal Registers, which store the data retrieved from the Modbus/RTU master, can be mapped to the supported northbound protocols, such as Modbus/TCP, SNMP, RESTful API, and MQTT.

Each block represents one internal register location. Internal registers that are being used are showed with a corresponding color bar at the top of the register, as shown below.

IR Type Drop-Down List: It lists all the IR types. Select the IR type to change or view its settings.

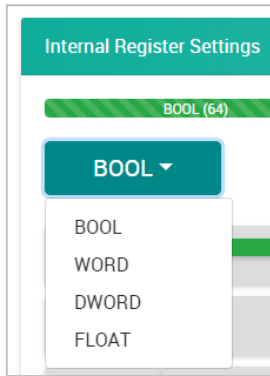

IR Quantity: Apply a number to adjust the quantity of the selected IR type. The total available IR quantity is 256.

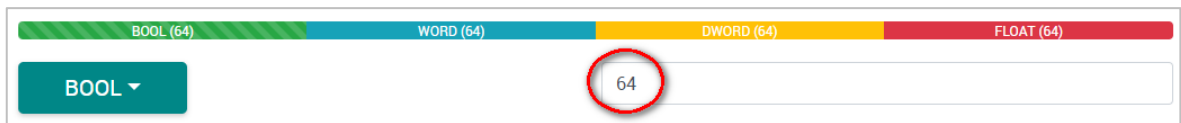

The default services allocated are BOOL, WORD, DWORD and FLOAT. If you need to use UWORD or UDWORD, you need to decrease the IR quantity of the current service and re-allocate the IR quantity to UWORD or UDWORD.

For example, you can decrease the IR quantity of BOOL to 32, and then assign to UWORD.

Example - Release IR from BOOL



Example - Re-allocate IR to UWORD

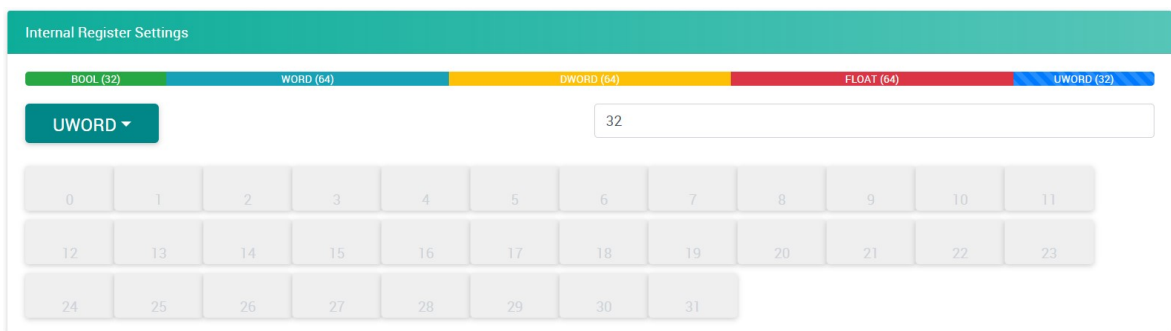

IR Information: The IR status window will pop-up after you click one of the IR blocks. The name is used for representing this internal register (max. length = 16, "." character is not allowed).

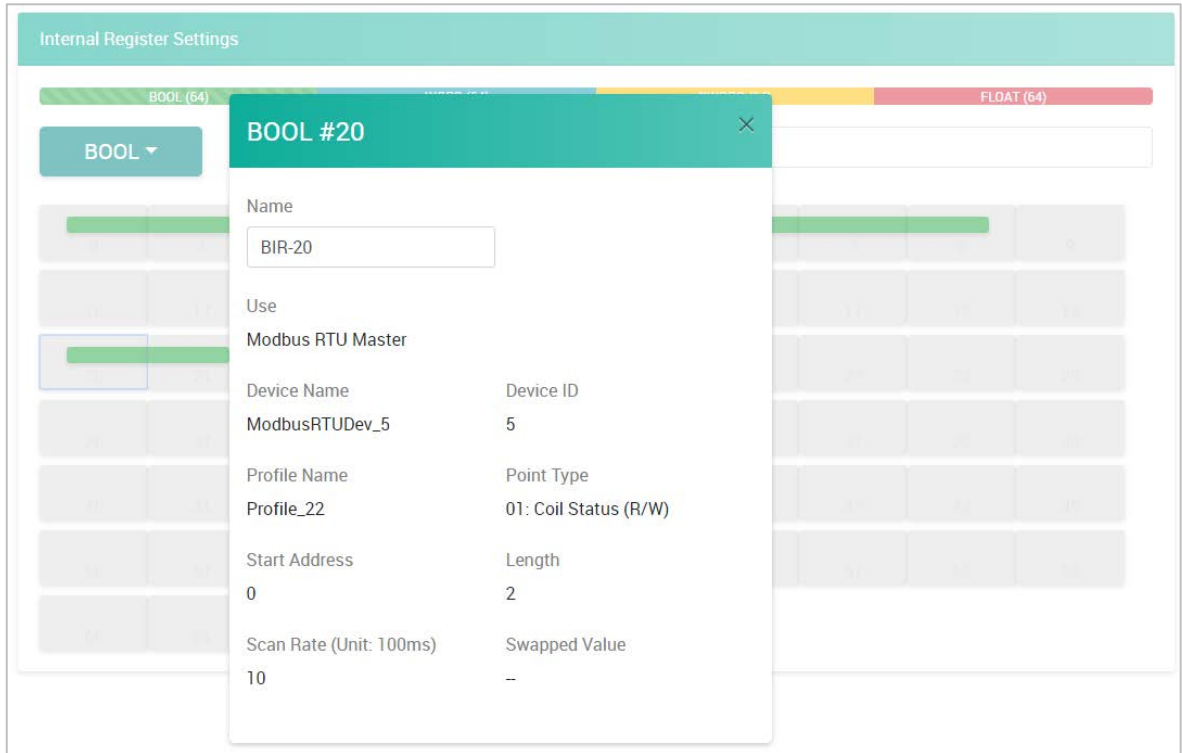

Protocol

This section introduces the protocol settings functions.

Modbus TCP Slave

The **Modbus TCP Slave** section shows the definition of the device's Modbus registers. It allows you to define your own data point type or address of the Modbus registers. The point type and address of a register can be default, existing configuration, or user-defined.

Load Default: Click this button to load default settings of all Modbus registers.

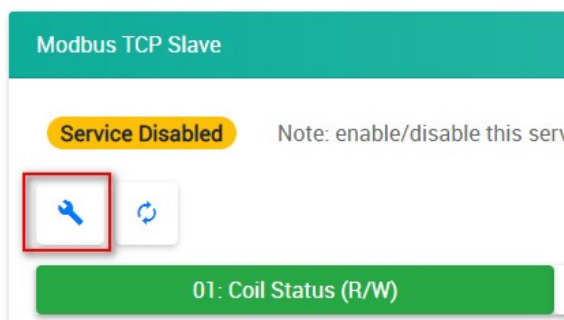

Reload Configuration: Click this button to reload the configuration settings of all Modbus registers.

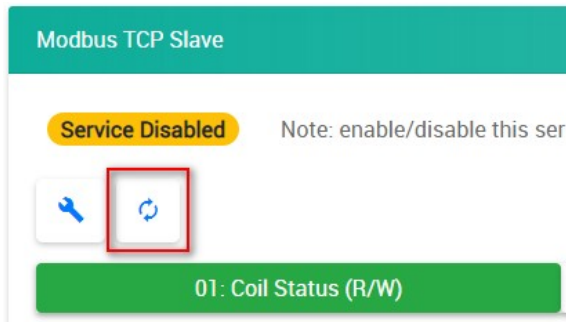

Filter: Type characters into the text box to filter the items in the Modbus Table.

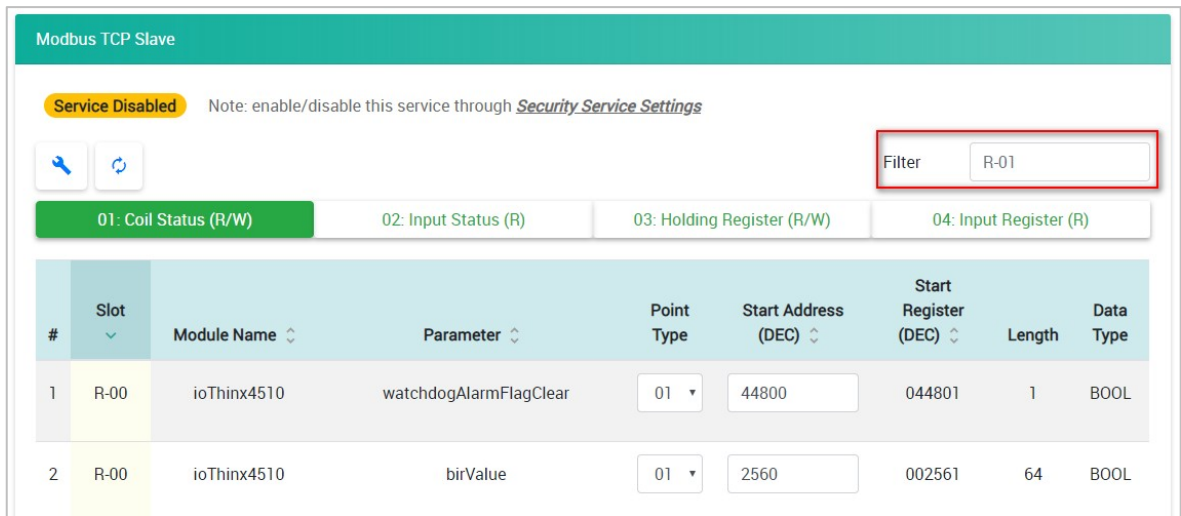

Point Type Category: Click **01: Coil Status (R/W)**, **02: Input Status (R)**, **03: Holding Register (R/W)**, or **04: Input Register (R)** tab to see the registers under the specific point type.



Point Type Drop-Down List: Select the point type of the parameter when it needs to move to the other point type. After you select the other point type, the parameter will disappear in the current-viewed category and will move to the point type category you just selected (option: 01, 02, 03, or 04).

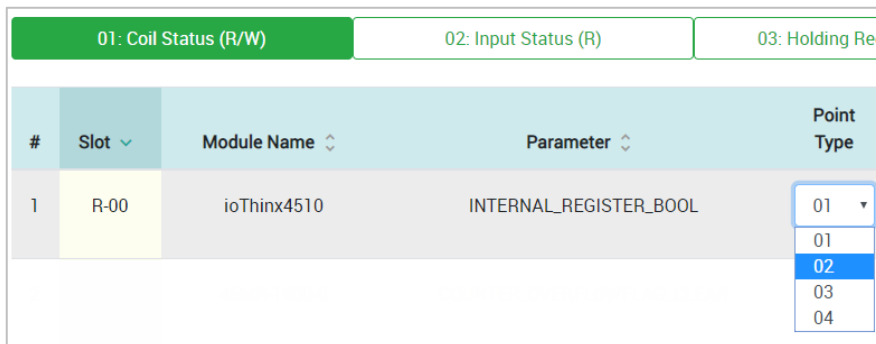

Start Address Textbox: Change the value of the Start Address in the text box (0 to 65535 or leave it blank). When there is no value in the text box, it will be displayed in light yellow. When it conflicts with another register, it will be displayed in red. Revise the value to prevent address conflict. You can use the **Sort** function to see where there is a conflict of addresses.

#	Slot	Module Name	Parameter	Point Type	Start Address (DEC)	Start Register (DEC)	Length	Data Type
1	R-04	45MR-2601-0	doStatus	01		-	16	BOOL
2	R-03	45MR-2600-0	doStatus	01	32	000001	16	BOOL
3	R-05	45MR-2606-0	doStatus	01	32	000033	8	BOOL

Sort: The default-sorted column is the **Slot** from the lowest to highest slot number. Click the green arrow to change the sorting method. Click the gray arrows on the other columns to sort that specific column.

#	Slot	Module Name	Parameter	Point Type	Start Address (DEC)	Start Register (DEC)	Length	Data Type
1	R-00	ioThinx4510	SYS_WATCHDOG_ALARM_FLAG_CLEAR	01	44800	044801	1	BOOL
2	R-00	ioThinx4510	INTERNAL_REGISTER_BOOL	01	2560	02561	1	BOOL



INFORMATION

Enable/disable this service through **Security > Service Settings**.



INFORMATION

In the event that a conflict address value is entered, whenever you click on a different point type tab, the previous configurations will be restored to avoid the conflict.



INFORMATION

Refer to [Modbus/TCP Slave Rules](#) for the available Modbus register.

SNMP

In the SNMP page, settings are divided into three tabs: SNMP, SNMP Trap/Inform, and Event Settings.

The screenshot shows the 'SNMP' tab selected in a navigation bar. The left sidebar contains a menu with 'SNMP' highlighted. The main content area is titled 'SNMP Settings' and features a green 'Service Enabled' status indicator. A note indicates that the service can be enabled or disabled through 'Security Service Settings'. Below this, there are three input fields: 'Version' (a dropdown menu showing 'v1 and v2c and v3'), 'Contact' (an empty text box), and 'Location' (an empty text box). A second section, 'SNMPv1, SNMPv2c Settings', contains two more input fields: 'Read Community' (with the value 'public') and 'Write Community' (with the value 'private').

SNMP Settings

This screenshot shows the 'SNMP Settings' page with the service status set to 'Service Disabled', indicated by a yellow badge. The note about enabling/disabling the service through 'Security Service Settings' is present. The 'Version' dropdown menu is set to 'v1 and v2c'. The 'Contact' and 'Location' fields are empty. The 'Read Community' and 'Write Community' fields are not visible in this view.

Version: Select one of the SNMP version options (option: v1 and v2c, v3 only, or v1 and v2c and v3), through which the SNMP Manager can access the SNMP agent of the device.

Contact: Type the contact of the SNMP server (max length = 30).

Location: Type the physical location of the SNMP server (max length = 30).



INFORMATION

Enable/disable this service through **Security > Service Settings**.

SNMPv1, SNMPv2c Settings

SNMPv1, SNMPv2c Settings	
Read Community	<input type="text" value="public"/>
Write Community	<input type="text" value="private"/>

Read Community: Type the community string matching for read authentication (max length = 30, default = "public").

Write Community: Type the community string matching for write authentication (max length = 30, default = "private").

SNMPv3 Settings – Read Only

SNMPv3 Settings – Read Only	
Username	<input type="text" value="v3ro"/>
Authentication Protocol	<input type="text" value="MD5"/>
Authentication Password	<input type="password" value="....."/>
Privacy Protocol	<input type="text" value="CBC-DES"/>
Privacy Password	<input type="password" value="....."/>

Username: Type the username for SNMP v3 settings (min. length = 1; max length = 30; A to Z, a to z, 0 to 9, symbols, spaces and .()[]{}"/\@"@;: symbols are not allowed, default = "v3ro").

Authentication Protocol: Select **Disable**, **MD5**, **SHA1**, **SHA-224**, or **SHA-256** for the authentication protocol setting (default: MD5).

Authentication Password: Type the password for the authentication password settings (min. length = 8; max length = 16; A to Z, a to z, 0 to 9, symbols, at least one symbol and one number, spaces and .()[]{}"/\@"@;: symbols are not allowed, default = "moxa-123").

Privacy Protocol: Select **Disable**, **CBC-DES**, or **AES-128** for privacy protocol setting (default: CBC-DES).

Privacy Password: Type the password for the privacy password settings (min. length = 8; max length = 16; A to Z, a to z, 0 to 9, symbols, at least one symbol and one number, spaces and .()[]{}"/\@"@;: symbols are not allowed, default = "moxa-123").

SNMPv3 Settings – Read/Write

SNMPv3 Settings – Read/Write

Username	<input type="text" value="v3rw"/>
Authentication Protocol	<input type="text" value="MD5"/>
Authentication Password	<input type="text" value="....."/>
Privacy Protocol	<input type="text" value="CBC-DES"/>
Privacy Password	<input type="text" value="....."/>

Username: Type the username for the SNMP v3 settings (min. length = 1; max length = 30; A to Z, a to z, 0 to 9, symbols, spaces and .()[]{}"/\@"@;: symbols are not allowed, default = "v3rw").

Authentication Protocol: Select **Disable**, **MD5**, **SHA1**, **SHA-224**, or **SHA-256** for the authentication protocol settings (default: MD5).

Authentication Password: Type the password for the authentication password settings (min. length = 8; max length = 16; A to Z, a to z, 0 to 9, symbols, at least one symbol and one number, spaces and .()[]{}"/\@"@;: symbols are not allowed, default = "moxa-123").

Privacy Protocol: Select **Disable**, **CBC-DES**, or **AES-128** for privacy protocol settings (default: CBC-DES).

Privacy Password: Type the password for the privacy password settings (min. length = 8; max length = 16; A to Z, a to z, 0 to 9, symbols, at least one symbol and one number, spaces and .()[]{}"/\@"@;: symbols are not allowed, default = "moxa-123").



INFORMATION

Refer to [SNMP Rules](#) for detailed SNMP OID information.

SNMP Trap and SNMP Inform

Trap/Inform Settings

Service Disabled (Invalid IP) Note: enable/disable this service through *Security Service Settings*

SNMP Trap	<input type="text" value="v1"/>		
SNMP Inform	<input type="text" value="v2c"/>		
1st Server IP	<input type="text" value="0.0.0.0"/>	2nd Server IP	<input type="text" value="0.0.0.0"/>
1st Server Port	<input type="text" value="162"/>	2nd Server Port	<input type="text" value="162"/>

SNMP Trap: Select one of the SNMP version options (option: v1, v2c, or v3), through which the SNMP server can receive the SNMP Trap from the SNMP agent.

SNMP Inform: Select one of the SNMP version options (option: v2c or v3), through which the SNMP server can receive the SNMP Inform from the SNMP agent.

IP: Type the IP address of the SNMP server.



NOTE

If the IP is 0.0.0.0, the ioThinx 4510 will not update the SNMP Trap/Inform to the server.

Port: Enter the port of the SNMP server(default = 162).

SNMPv1 And SNMPv2c			
1st Server Trap Community	<input type="text" value="public"/>	2nd Server Trap Community	<input type="text" value="public"/>

Trap Community: Type the community string matching for read authentication (max length = 30, default = "public").

SNMPv3			
1st Server Username	<input type="text" value="v3"/>	2nd Server Username	<input type="text" value="v3"/>
1st Server Authentication Protocol	<input type="text" value="MD5"/>	2nd Server Authentication Protocol	<input type="text" value="MD5"/>
1st Server Authentication Password	<input type="text" value="....."/>	2nd Server Authentication Password	<input type="text" value="....."/>
1st Server Privacy Protocol	<input type="text" value="CBC-DES"/>	2nd Server Privacy Protocol	<input type="text" value="CBC-DES"/>
1st Server Privacy Password	<input type="text" value="....."/>	2nd Server Privacy Password	<input type="text" value="....."/>
1st Server Engine ID Format	<input type="text" value="ASCII"/>	2nd Server Engine ID Format	<input type="text" value="ASCII"/>
1st Server Engine ID	<input type="text" value="moxa-123"/>	2nd Server Engine ID	<input type="text" value="moxa-123"/>

Username: Type the username for the SNMP v3 settings (min. length = 1; max length = 30; A to Z, a to z, 0 to 9, symbols, spaces and .()[]{}"/\@"@;: symbols are not allowed, default = "v3").

Authentication Protocol: Select **Disable**, **MD5**, **SHA1**, **SHA-224**, or **SHA-256** for the authentication protocol settings (default = MD5).

Authentication Password: Type the password for the authentication password settings (min. length = 8; max length = 16; A to Z, a to z, 0 to 9, symbols, at least one symbol and one number, spaces and .()[]{}"/\@"@;: symbols are not allowed, default = "moxa-123").

Privacy Protocol: Select **Disable**, **CBC-DES**, or **AES-128** for privacy protocol settings (default = CBC-DES).

Privacy Password: Type the password for the privacy password settings (min. length = 8; max length = 16; A to Z, a to z, 0 to 9, symbols, at least one symbol and one number, spaces and .()[]{}"/\@"@;: symbols are not allowed, default = "moxa-123").

Engine ID format: Select **ASCII** or **HEX** for the engine ID (default = ASCII).

Engine ID: Type the engine ID to use (max length = 32 (ASCII) / 64 (HEX), default = "moxa-123")



NOTE

In HEX format, please add a "0" for single-digit engine IDs. (e.g. "3" should be "03").

Event Settings

System Event Setting

Enable System Event Alert

Enable System Event Alert: Enable the SNMP Traps related to system information. The Trap items are listed in the table below.

Item	Description
Boot-up	Triggers when each boot-up procedure is completed and "ready" is reached.
Reboot	Triggers when issuing a command to restart.
Login failure	Triggers when the username or password is entered incorrectly.
Module mismatch	Triggers when device status is "Module mismatch".
Internal bus error	Triggers when device status is "Internal bus error".
Safe mode	Triggers when device status is "Safe mode".

I/O Event Setting

#	Module Name	Channel Name	Mode/Range	Trigger	Value	Hysteresis	Alert Type	Specific ID
1	45MR-260	DI-00	DI	On Chan	-	-	SNMP Tr	1
2	45MR-380	AI-00	4.000 - 20.000	Greater	4.000	0.000	SNMP Int	1

ADD NEW ALERT (2/64)

Each row in this page represents one monitored event.

Click the exit delete icon to delete the event:



Click the duplicate icon to duplicate the event:



The ioThinX 4510 supports a maximum of 64 events. Click **ADD NEW ALERT** to create a new event.

Module Name: Select a module. Only input modules will be listed here.

Channel Name: Select the channel you want to monitor the event.

Trigger: Select the event trigger type. For Digital Input, there are three options, **On Change**, **ON to OFF**, and **OFF to ON**. For Analog Input, the two trigger options are **Greater** and **Less**.

Value: Type the threshold value of the trigger. This is only used for Analog Input events.

Hysteresis: Type the hysteresis value of the trigger. This is only used for Analog Input events.

For illustration purposes, consider the following example where we set the AI-00 channel's trigger value to be greater than 5 with a hysteresis of 1, and also smaller than 5 with a hysteresis of 1.

#	Module Name	Channel Name	Mode/Range	Trigger	Value	Hysteresis	Alert Type	Specific ID
1	45MR-3800-0	AI-00	4.000 - 20.000	Greater	5.000	1.000	SNMP TRAP	1
2	45MR-3800-0	AI-01	4.000 - 20.000	Less	5.000	1.000	SNMP TRAP	1

When Trigger = Greater, Value = 5, and Hysteresis = 1, the SNMP trap will only be triggered if the analog signal fluctuates from 4 to 5, as depicted in Scenario 1 below. However, if we change the settings to Value = 5 and Hysteresis = 2, the SNMP trap will only be triggered if the analog signal fluctuates from 3 to 5.

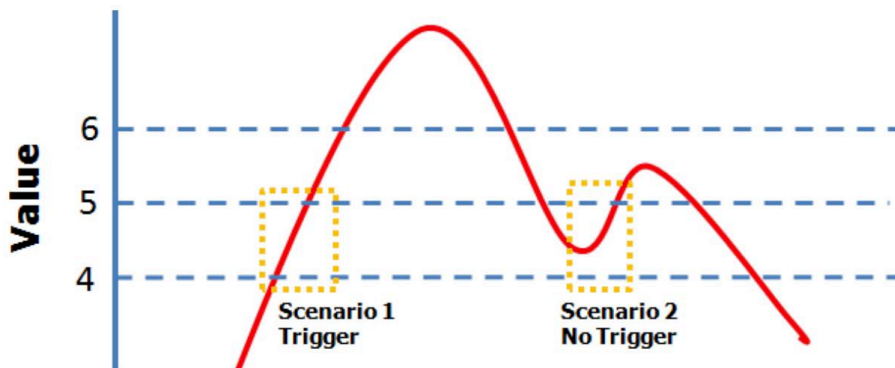

When Trigger = Less, Value = 5, and Hysteresis = 1, the SNMP trap will only be triggered if the analog signal fluctuates from 6 to 5, as depicted in Scenario 1 below. However, if we change the settings to Value = 5 and Hysteresis = 2, the SNMP trap will only be triggered if the analog signal fluctuates from 7 to 5.

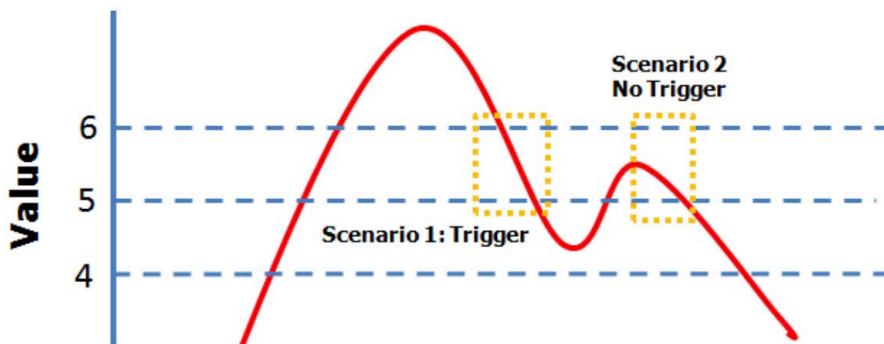

MQTT

The ioThinX 4510 supports MQTT version 3.1.1. In this section, we introduce the MQTT settings. The MQTT configuration page has two channels: **Connection Settings** and **Topic Settings**.

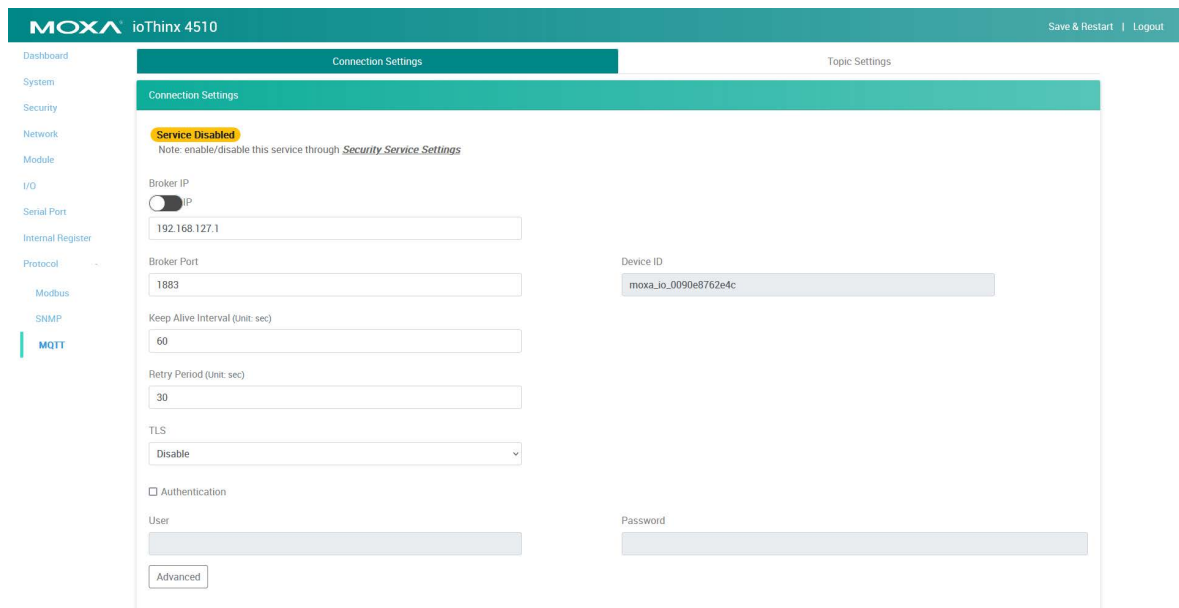

Connection Settings

Broker IP: Choose an IP address or domain name for the MQTT broker.

Broker Port: Specifies the broker port in this column.

Authentication: Select the Authentication checkbox to enable the username and password settings. The username and password are used when an MQTT client connects to a broker.

Keep Alive Interval: Keep alive is designed to ensure that a connection between the MQTT client and broker exists. The ioThinx 4510 will send the keep alive packets to the broker at designated intervals.

Device ID: The Device ID is used by the broker to identify each client that is connected to it. The ioThinx 4510's Device ID is unique and cannot be changed. The ID comprises the prefix **moxa_io_** followed by the MAC address of the ioThinx 4510.

TLS: The ioThinx 4510 uses TLS to encrypt MQTT transmissions. You may enable or disable TLS.



WARNING

If TLS encryption is disabled, **the username and password will be transmitted in plain text.**

Advanced

Click the Advanced button to view the Last Will & Testament Settings.

Advanced

Last Will & Testament

Last Will Topic	Last Will Message
ioThinx_4510/read/lastwill	Device is offline
Last Will QoS	Retained
0	Disable

Last Will Topic: The "topic" of the last will message that will be sent to the broker. This item is not configurable.

Last Will Message: The message that will be sent to the broker when the connection between the ioThinx 4510 and the broker is disconnected. This item is not configurable.

Last Will QoS: The ioThinx supports three QoS levels:

- QoS 0 (at most once): Data is delivered without acknowledgement. This level of QoS provides best-effort delivery but without guarantee.
- QoS 1 (at least once): Data is delivered with acknowledgement. In this case, when the ioThinx 4510 sends data, it expects to receive an Ack back from broker. With this level of QoS, data may be delivered multiple times.
- QoS 2 (exactly once): Data is delivered exactly once using a "four-part-handshake". This level of QoS is the most reliable, but is generally slower than QoS 0 and QoS 1.

Retained: The broker will save messages that are not delivered to a subscriber who is offline when the message is first delivered and then resend the message when the subscriber comes back online.

Topic Settings

All the topics provided by the ioThinx 4510 will be listed here. The topics are default disabled. You need to select the topics that must be enabled. The topic which can be published or subscribed are listed in the page **Publication** or **Subscription**, respectively.

The screenshot displays the 'Topic Settings' page for the ioThinx 4510. At the top, there's a navigation bar with 'MOXA ioThinx 4510' and 'Save & Restart | Logout'. The main content area is titled 'Topic Settings' and contains a 'Batch Edit' section with various configuration buttons. Below this is a 'Topic Table' with the following data:

#	Enable	Slot	Channel	Topic	QoS	Retained	Trigger	Condition
1	<input type="radio"/>	R-01	DI-00	ioThinx_4510/read/45MR-1601-0@DI-00/diStatus	0	<input type="radio"/>	On Change	- (Unit: %)
2	<input type="radio"/>	R-01	DI-01	ioThinx_4510/read/45MR-1601-0@DI-01/diStatus	0	<input type="radio"/>	On Change	- (Unit: %)
3	<input type="radio"/>	R-01	DI-02	ioThinx_4510/read/45MR-1601-0@DI-02/diStatus	0	<input type="radio"/>	On Change	- (Unit: %)
4	<input type="radio"/>	R-01	DI-03	ioThinx_4510/read/45MR-1601-0@DI-03/diStatus	0	<input type="radio"/>	Interval	5 (Unit: sec)
5	<input type="radio"/>	R-01	DI-04	ioThinx_4510/read/45MR-1601-0@DI-04/diStatus	0	<input type="radio"/>	Interval	5 (Unit: sec)
6	<input type="radio"/>	R-01	DI-05	ioThinx_4510/read/45MR-1601-0@DI-05/diStatus	0	<input type="radio"/>	On Change	- (Unit: %)
7	<input type="radio"/>	R-01	DI-06	ioThinx_4510/read/45MR-1601-0@DI-06/diStatus	0	<input type="radio"/>	On Change	- (Unit: %)

Filter: The ioThinx 4510 has a filter function in the top right corner of the subscriber page that allows users to find topics more easily. Click the **Value/Attribute/Enable/Disable** buttons and then type a keyword to find a topic within several seconds. The number of filtered topics will be shown as well.

Value/Attribute: The following most frequently used IO data will be filtered by **Value**. Other IO data, which is not listed, will be filtered by **Attribute**.

- diStatus
- diCounterValue
- diCounterStauts
- doStatus
- doPulseStatus
- relayStatus
- relayCurrentCount
- aiStatus
- aiValueScaled
- aoStatus
- aoValueScaled
- rtdStatus
- rtdValueScaled
- tcStatus
- tcValueScaled

Enable/Disable: Filter out the enabled or disabled topic.

Textbox: Type in the topic that you would like to filter.

Batch Edit: The ioThinx 4510 supports the **Enable/Disable/QoS/Retain/Trigger** function for batch editing. When the batch edit function is clicked, all filtered topics will be set. If the topic does not support the batch edit function (e.g., the topic does not support On Change but the user batch edits all), the edit will be skipped by the topic.



NOTE

The ioThinx 4510 only supports 256 topics. If there are over 256 filtered topics, the enable button will be disabled.

Topic Table: All data that can be published or subscribed is listed in the table on the Publisher or Subscriber page.

Slot: The slot associated with the data.

Channel: The channel associated with the data.

Topic: Topics include the following items:

- Publish: {deviceName}/read/{ioName}/{parameters}
- Subscribe: {deviceName}/write/{ioName}/{parameters}
 - **{deviceName}**: the device name which user specified in **Device Setting** Page
 - **{ioName}**: the {ioName} is in the format {moduleName@channelName}. User can specify the module name in **Module** page and channel name in **I/O** pages, respectively.
 - **{Parameters}**: the parameters is showed the data which will be accessed by MQTT. Please refer to the Appendix for the detail description of data.

QoS: The QoS of each topic. It shares the same level with Slot/Channel/Topic.

Retain: Enables the retain function to force the broker to keep the latest data and send it to subscribers when subscribers are back online.

Trigger and Condition: Determines how the topic will be published.

- Interval: The topic will be published at specific intervals.
- OnChange: The topic will be published when the change criteria are met:
 - For Digital Input, the topic will be published when the value changes.
 - For Analog Input, the topic will be published when a specific percentage of the data changes compared with the previous update. The percentage refers to the full range.



NOTE

Setting a short interval may cause an unsuccessful publish.



NOTE

When ioThinx 4510 powers up, the device will send the data of the topics to be published to the MQTT broker, ensuring the completeness and accuracy of the data on the broker.

5. Configuring the ioThinX 4510

Configuring the Unit

This section explains how to configure this device through the web console from the beginning. If you require additional information, please refer to [Preparing Software Tools](#) before reading this section.

Log In to the Unit

Follow the steps to log in to the unit.

- Step 1:** Open your web browser and type the default IP address of the device, 192.168.127.254.
- Step 2:** On the login page, type the default username/password (admin/moxa) to log in to the Web Console.

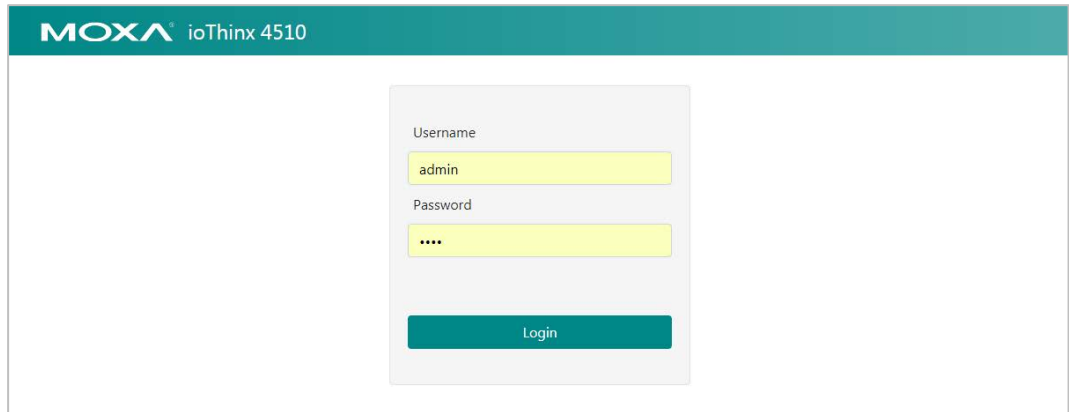

The screenshot shows the login interface for the Moxa ioThinX 4510. At the top, there is a teal header bar with the Moxa logo and the text 'ioThinX 4510'. Below the header, the main content area is white. In the center, there is a light gray box containing the login form. The form has two input fields: 'Username' with the text 'admin' entered, and 'Password' with four dots representing a masked password. Below the input fields is a teal button labeled 'Login'.

Configuring Module Settings

After you have logged in, you can see the dashboard or the module settings page. If the detected module matches the configured module, you will see the **Dashboard** as below. Then click **Module** in the Menu panel to go to the module settings page.

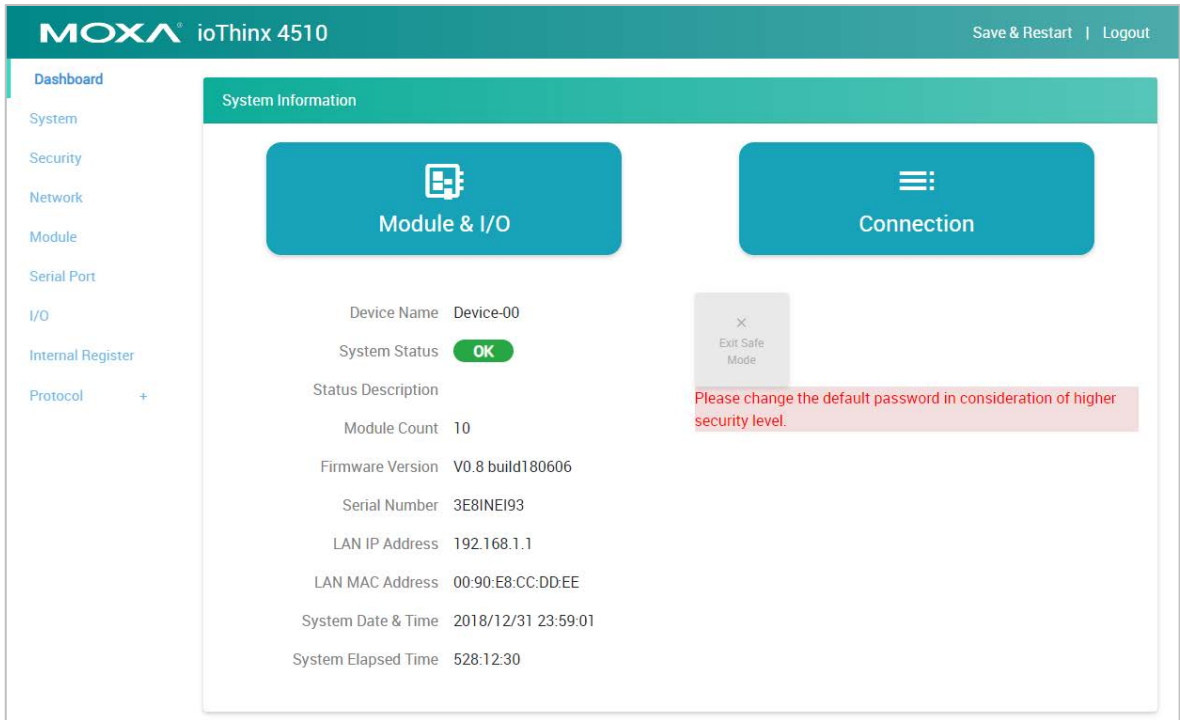

If you see the module settings page as opposed to the dashboard, click **Edit** to enter the edit mode and start editing the module settings.

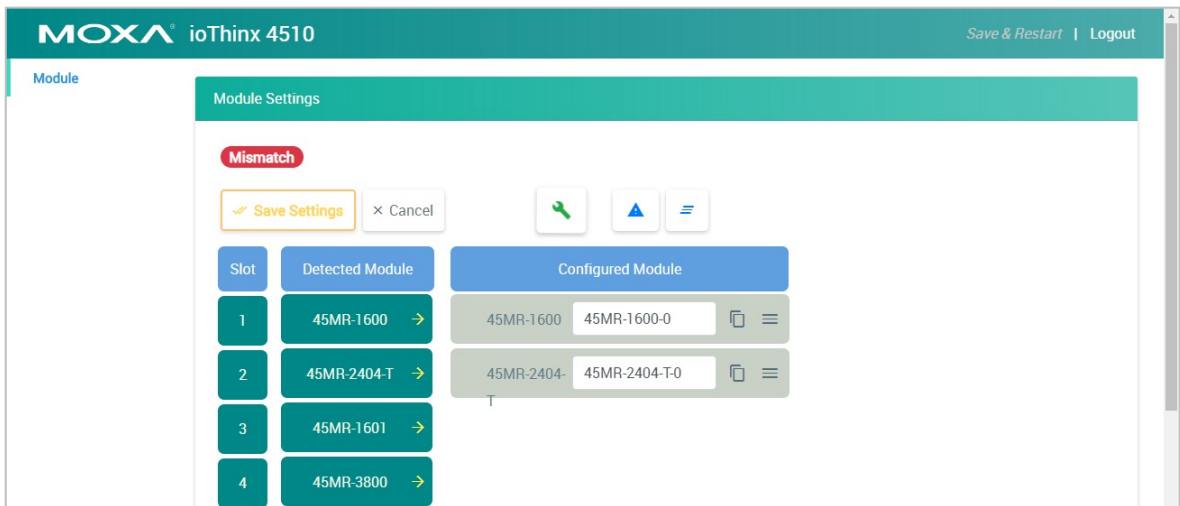

In edit mode, if any detected modules and configured modules do not match, then the configured modules will be highlighted as shown below.

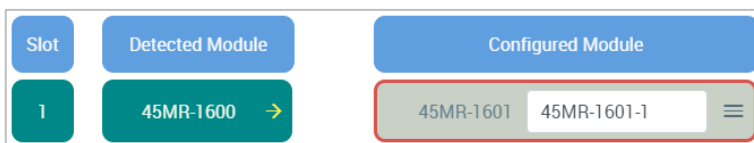

Click **Auto Matching** to match the conflicted modules.

If not, you can use the "Auto Match" function or swap the module to change the module sequence.

If you want to rearrange the 45MR modules automatically, you can click "Auto Match".

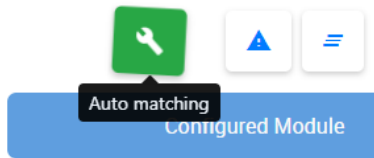

If you want to change configurations, use the swap function. To swap the module sequence, move the point to the module, click the left button on the mouse and hold it. After the module color changes to green, you can move it to change the position of the module.

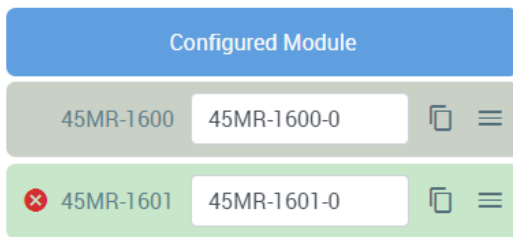

Changing Device Name

Set the name of this device through **System > Device Settings**. We recommend choosing a unique name for the device to easily differentiate it from other devices.

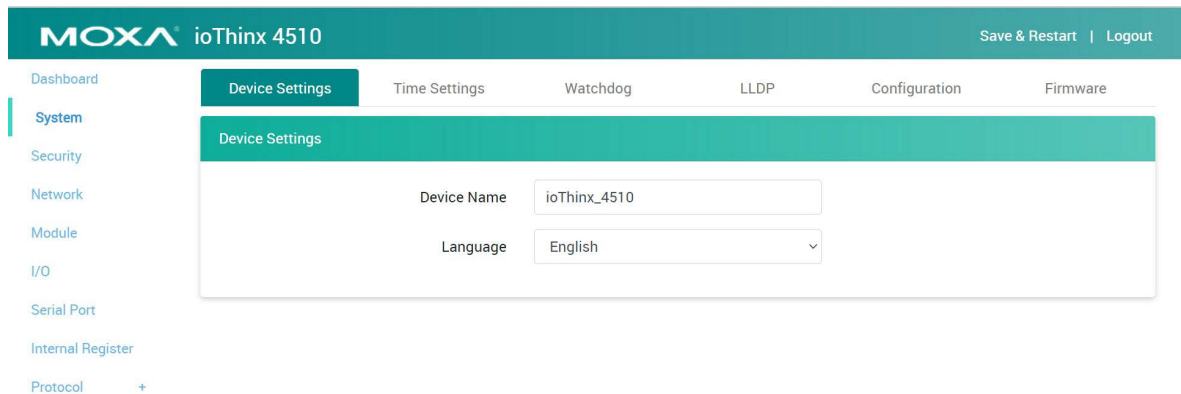

Changing the Username and Password

To have higher levels of security, we recommend changing the username and password after your first login. Click **Security > User Settings** as shown in the screenshot below.

The screenshot shows the MOXA ioThinX 4510 web interface. The top navigation bar includes 'MOXA ioThinX 4510' and 'Save & Restart | Logout'. The left sidebar has 'Security' selected. The main content area is titled 'User Settings' and contains a table of users and a form to create a new user.

No.	Type	Username	Permissions
1	Administrator	admin	Full control
2	Operator	operator	Dashboard and I/O status change
3	User	user	Dashboard

Form fields for creating a new user:

- Type: Administrator (dropdown)
- Enable:
- New Username: (Must be 1-30 characters. Cannot include spaces, but letters, numbers, and symbols are allowed.)
- Admin Password:
- New Password: (Must be 4-16 characters. Letters, numbers, and symbols are allowed. Must include at least one number and one symbol.)
- Confirm Password:



INFORMATION

The default username is admin, and the default password is moxa.

Configuring Service Settings

Click **Security** on the menu panel to enter the security settings page, as shown below. For service settings, the user can enable or disable the service control access.

The screenshot shows the MOXA ioThinX 4510 web interface. The top navigation bar includes 'MOXA ioThinX 4510' and 'Save & Restart | Logout'. The left sidebar has 'Security' selected. The main content area is titled 'Service Settings' and contains a table of services.

No.	Service	TCP/UDP	Port
<input checked="" type="checkbox"/> 1	Web Service via HTTP	TCP	80
<input type="checkbox"/> 2	Web Service via HTTPS <small>1. MUST import self-signed certificate before enabling the web service via HTTPS, or the browser may block the connection. 2. The maximum number of 45MR module is eight slots when the HTTPS web service and two of following three protocols (SNMP / Modbus TCP / Modbus RTU), are enabled simultaneously.</small>	TCP	443
<input type="checkbox"/> 3	RESTful API via HTTP	TCP	80
<input type="checkbox"/> 4	RESTful API via HTTPS	TCP	443
<input type="checkbox"/> 5	SNMP Agent/Trap/Inform	UDP	161
<input type="checkbox"/> 6	Modbus/TCP Slave	TCP	502
<input type="checkbox"/> 7	Modbus/RTU Master	-	-
<input type="checkbox"/> 8	MQTT Client	TCP	-
<input type="checkbox"/> 9	LLDP	UDP	-
<input checked="" type="checkbox"/> 10	iOxpress/MCC Tool/MXIO	TCP/UDP	10124/4800

Configuring Account Settings

For account settings, you can change the parameters and define the login failure message and system usage notifications. If you want to know the access history, the ioThinx 4510 Series supports access log export, which can store up to 1000 records.

The screenshot shows the 'Account Settings' page in the MOXA ioThinx 4510 web interface. The page is titled 'Account Settings' and is part of a navigation menu that includes 'Service Settings', 'User Settings', 'Access Control', and 'Certificate Settings'. The left sidebar shows a menu with 'Security' selected. The main content area contains the following settings:

- Idle Timeout (Unit: min(s)): 5
- Retry Failure Threshold (Unit: time(s)): 5
- Lockout Time (Unit: min(s)): 5
- Login Failure Message: (text input field)
- System Use Notification: (text input field)
- Enable Local SysLog:
- Local SysLog: Export (max: 2000 records) and Clear buttons
- Enable Remote SysLog:
- Remote SysLog Server: IP and text input field containing '192.168.127.1'
- Remote SysLog Facility: local0 (dropdown menu)
- Remote SysLog Severity: information (dropdown menu)

Configuring Network Settings

Click **Network** on the menu panel to enter the network settings page, as shown below. The ioThinx 4510 Series supports Ethernet daisy-chain topology with one MAC address. For this LAN port, it supports static IP and DHCP mode. The user can configure it via the LAN settings.

The screenshot shows the 'LAN Settings' page in the MOXA ioThinx 4510 web interface. The page is titled 'LAN Settings' and is part of a navigation menu that includes 'Dashboard', 'System', 'Security', 'Network', 'Module', 'Serial Port', 'I/O', 'Internal Register', and 'Protocol'. The left sidebar shows a menu with 'Network' selected. The main content area contains the following settings:

- IP Configuration: Static IP (dropdown menu)
- IP Address: 192 . 168 . 127 . 254
- Netmask: 255 . 255 . 255 . 0
- Gateway: 0 . 0 . 0 . 0
- DNS1: 0 . 0 . 0 . 0
- DNS2: 0 . 0 . 0 . 0

Configuring Serial Port and IR Settings

Click **Serial Port** on the menu panel to enter the serial port settings page. For more detailed information, please refer to the [Serial Port](#) section in Chapter 4.

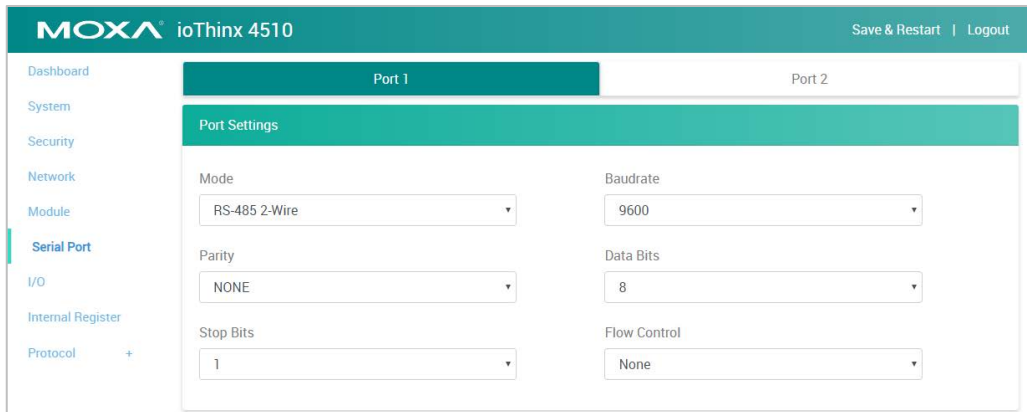

Click **Internal Register** on the menu panel to enter the internal register settings page. For more detailed information, please refer to the [Internal Register](#) section in Chapter 4.

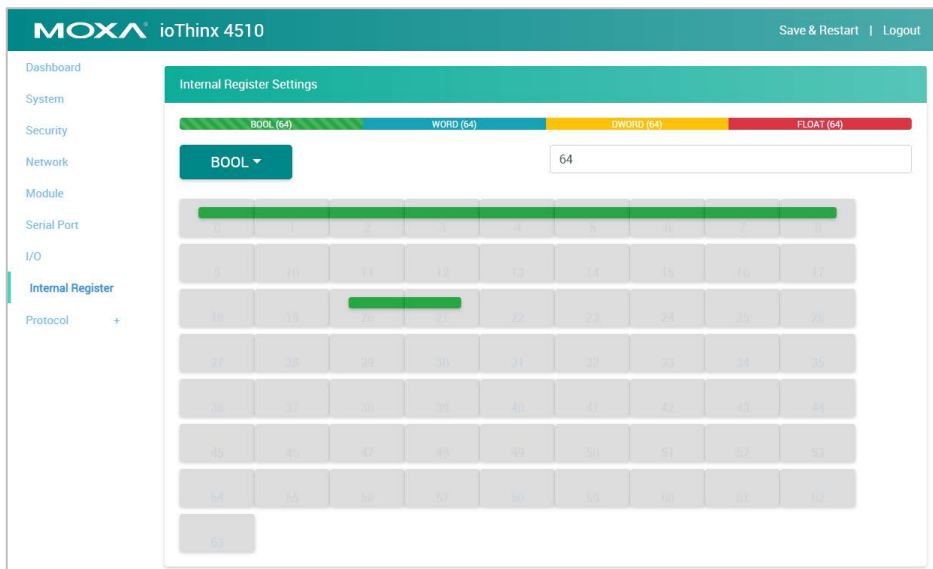

Configuring I/O Settings

Click **I/O** on the menu panel to enter the I/O settings page. For more detailed information, please refer to the [I/O Settings](#) section in Chapter 4.



Configuring Modbus Address Settings

Click **Modbus** on the menu panel to enter the Modbus TCP Slave setting page. On this page, you can see all the Modbus TCP addresses categorized by coil status, input status, holding register, and input register.

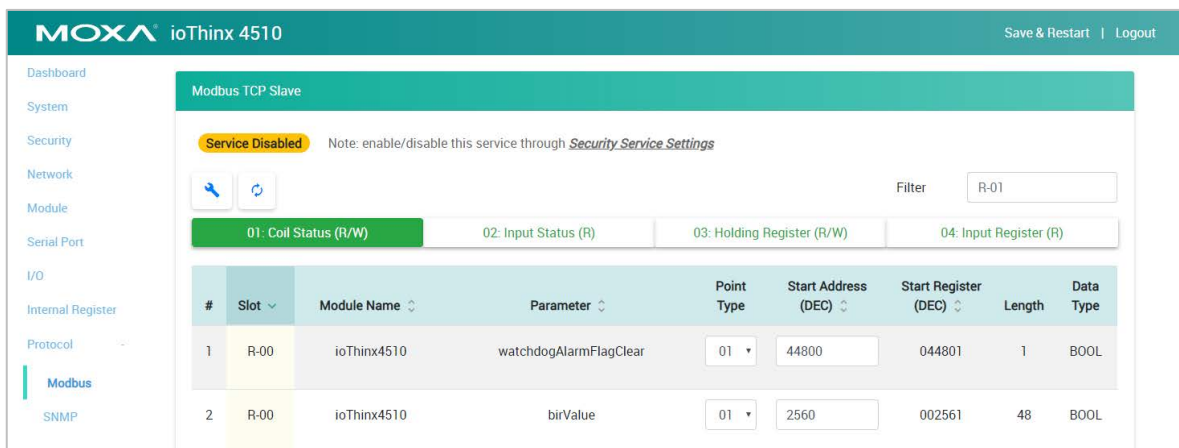

To change Modbus addresses, you can click **Reload default Modbus address**, **Reload current device address**, or manually change the addresses.

Configuring SNMP Settings

Click **SNMP** on the menu panel to enter the SNMP settings page as shown below.

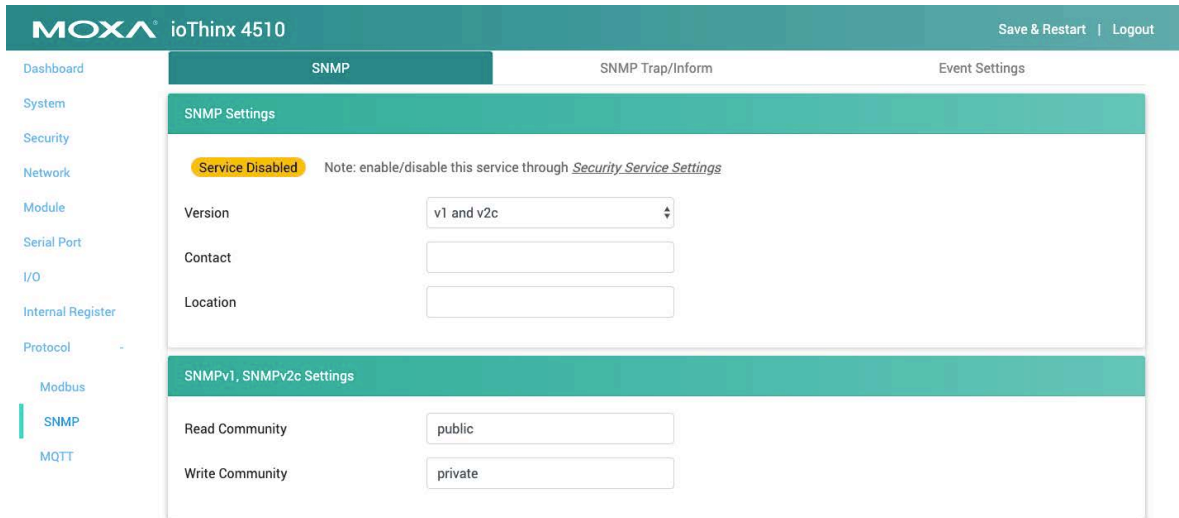

The ioThinX 4510 Series supports SNMP, SNMP Trap, and SNMP Inform. After configuring these settings, please download the mib file from Moxa's website. For detailed information on the structure of the mib file, please refer to the [SNMP](#) section in Chapter 4.

Configuring MQTT Settings

Click **MQTT** on the menu panel to enter the MQTT settings page, as shown below.

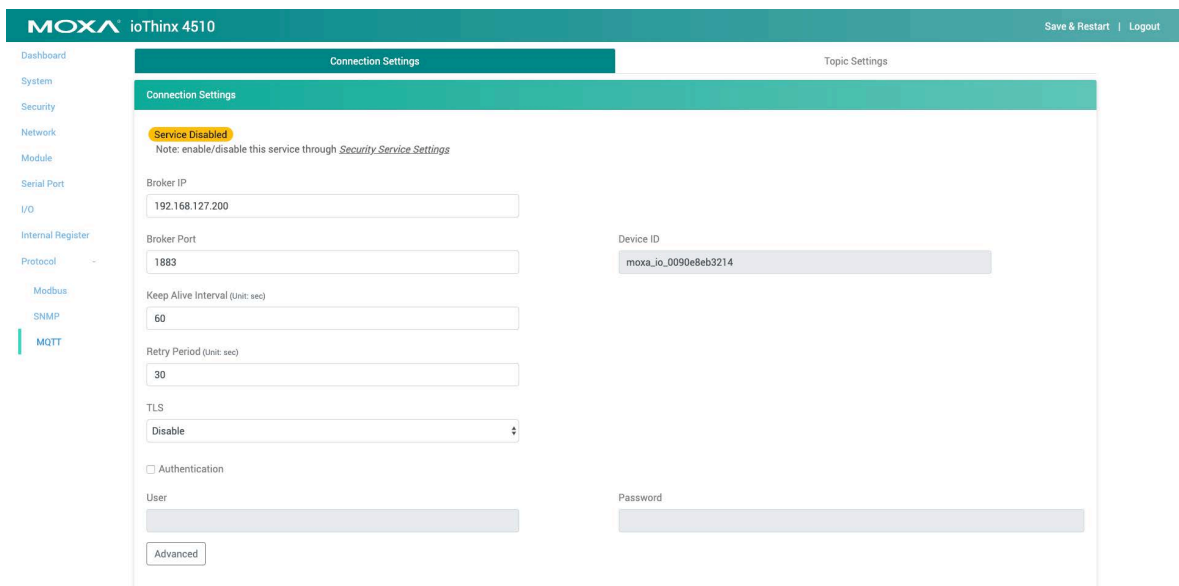

The ioThinX 4510 supports generic MQTT, and after configuring it, the ioThinX 4510 will connect the MQTT broker automatically. For detailed information about topics and payloads, refer to the [MQTT](#) section in Chapter 4.

Mass-deploying the Settings

The mass-deploying function can be performed by IOxpress utility. IOxpress is a Windows utility, and the system requirements are listed below:

OS	Microsoft Windows 2000, XP or later
CPU	Intel Pentium 4 CPU or higher
RAM	Min. 512 MB, 1024 MB is recommended
Network	10/100 Ethernet



NOTE

The ioThinx 4510 Series is only compatible with IOxpress v2.4 or later.



INFORMATION

To get the latest version of IOxpress, please download it from www.moxa.com

You can import/export configurations, update firmware, set the date and time, retrieve system log, change IP, change device name, get HTTPs certificate, restart device and load factory default by IOxpress. Before using the mass-deploying function, please complete the following steps to search for all devices first.

Step 1: Make sure the IOxpress service is enabled in **Security > Service Settings**.

The screenshot shows the MOXA ioThinx 4510 web interface. The 'Service Settings' page is active, displaying a table of services. The service 'IOxpress/MCC Tool/MXIO' (No. 9) is highlighted with a red box, and its checkbox is checked. The table lists various services with their respective ports and protocols.

No.	Service	TCP/UDP	Port
<input checked="" type="checkbox"/>	1	TCP	80
<input type="checkbox"/>	2	TCP	443
<input type="checkbox"/>	3	TCP	80
<input type="checkbox"/>	4	TCP	443
<input type="checkbox"/>	5	UDP	161
<input type="checkbox"/>	6	TCP	502
<input type="checkbox"/>	7	-	-
<input type="checkbox"/>	8	TCP	-
<input checked="" type="checkbox"/>	9	TCP/UDP	10124/4800

Step 2: Connect the devices by Ethernet cables and then power them on.

Step 3: Open IOxpress, go to the **Device Library** and click **Device > Search** in the menu.

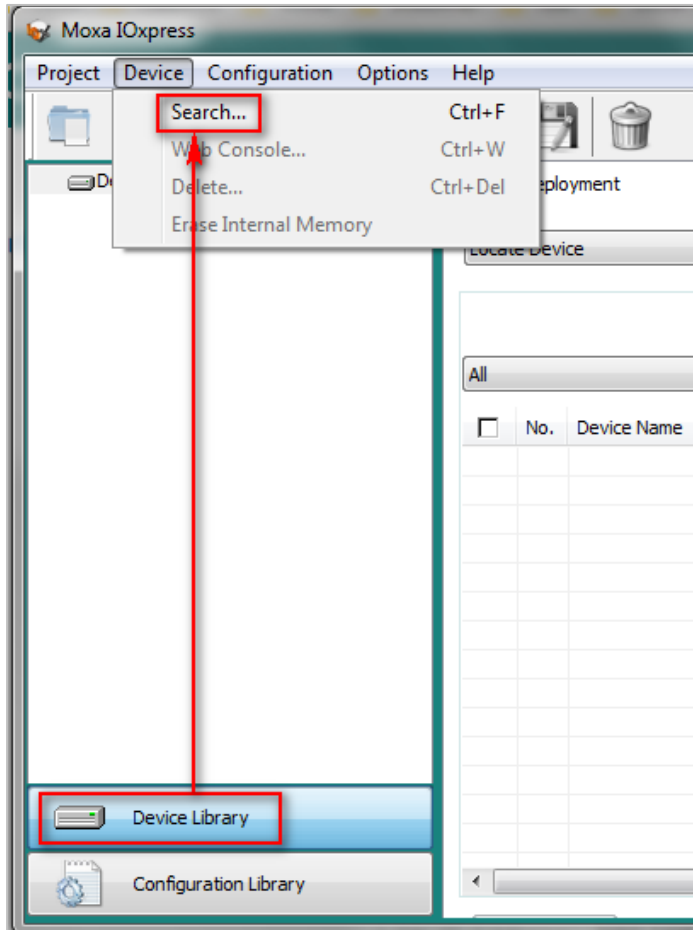

Step 4: Step 4: In the **Search for Devices** window, choose the product series you would like to search for in the **By Product Series** dropdown menu, and then click **Submit**. IOxpress will search the devices and list them in the table.

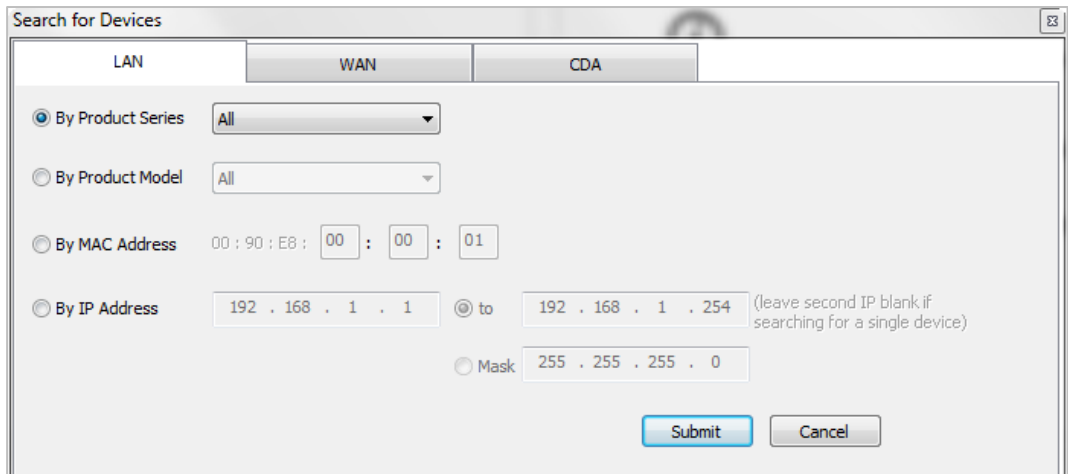

NOTE

If the devices cannot be found, check the network setting of the devices.



NOTE

The ioThinx 4510 supports only LAN search when using IOxpress.

Updating Configuration to Multiple Units

IOxpress supports updating configuration of multiple units. Follow the steps to complete this task.

Step 1: Export the configuration file of a device through the web console. Refer to [Backing up Configuration Files](#) for more details.

Step 2: Select **Update Configuration to Device** in the dropdown menu.

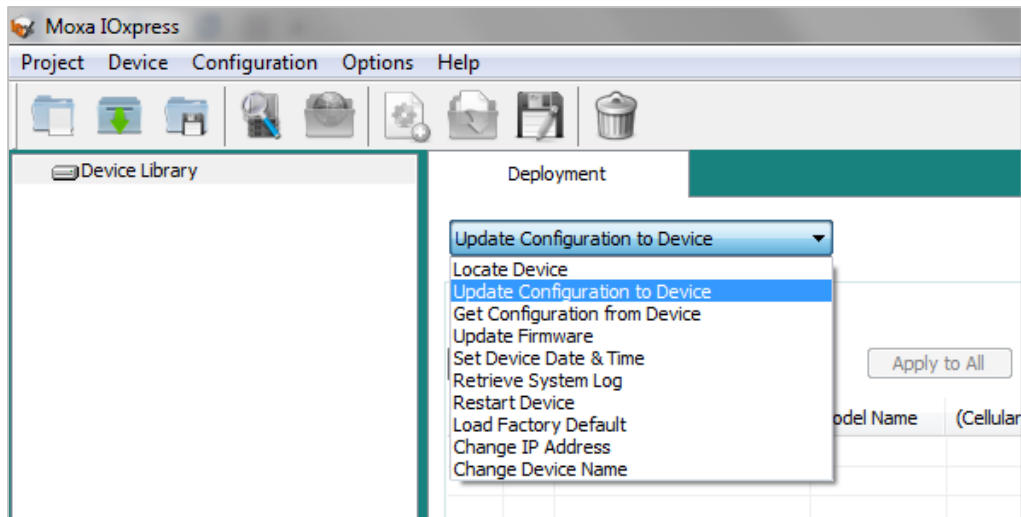

Step 3: Click the **File** column of the selected device in the table and then choose the configuration file from Step 1.

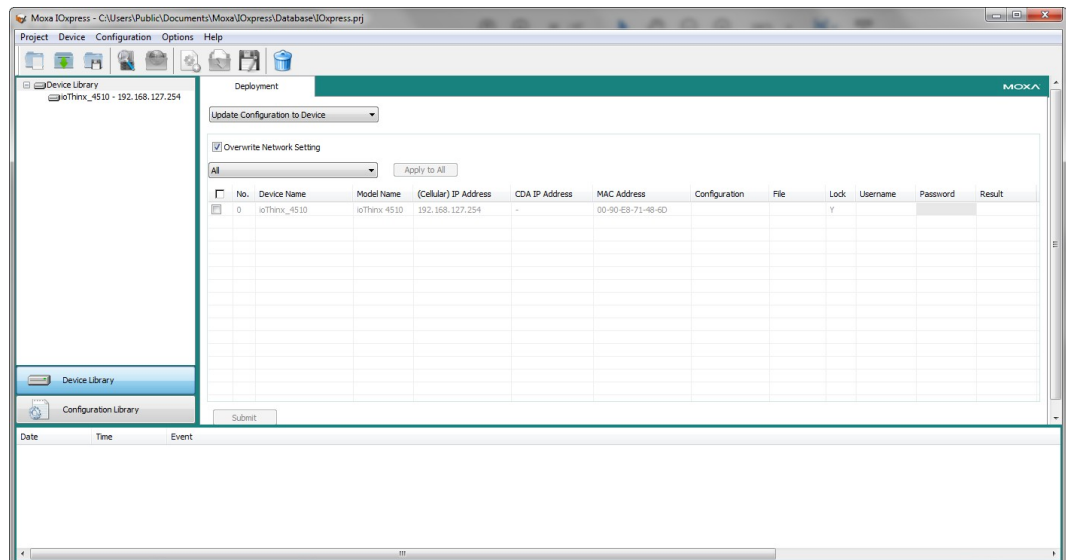

Step 4: Select the device(s), type the **username** and **password**, and then click **Submit**. Then, IOxpress will execute the task on the selected devices. A message stating that the action was successful will show up in the **Result** column if the process is successfully completed.



INFORMATION

Click **Apply to All** if the selected devices have the same settings.



INFORMATION

Back up the configuration before updating to a new configuration.

Setting Date and Time to Multiple Units

The IOxpress supports setting the date and time of multiple units. Follow these steps to complete this task.

Step 1: **Step 1:** Select **Set Device Date & Time** in the dropdown button

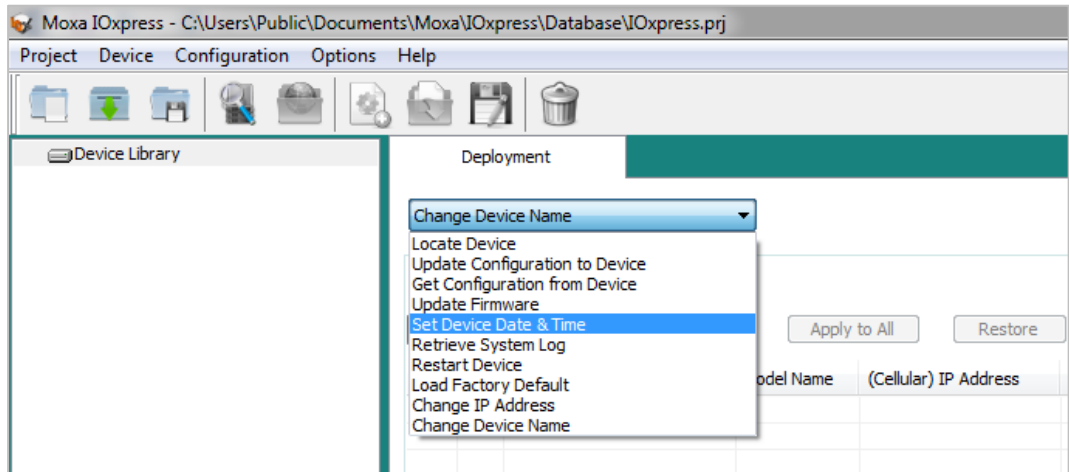

Step 2: Select either **Sync with PC** or **Manual Setting**. For manual setting, type the Local Date and Time, which will be set on the device(s).

Step 3: Select the device(s), type the **username** and **password**, and then click **Submit**. IOxpress will execute the task on the selected devices. A message stating that the action was successful will show up in the **Result** column if the process is successfully completed.



INFORMATION

Click **Apply to All** if the selected devices have the same settings.

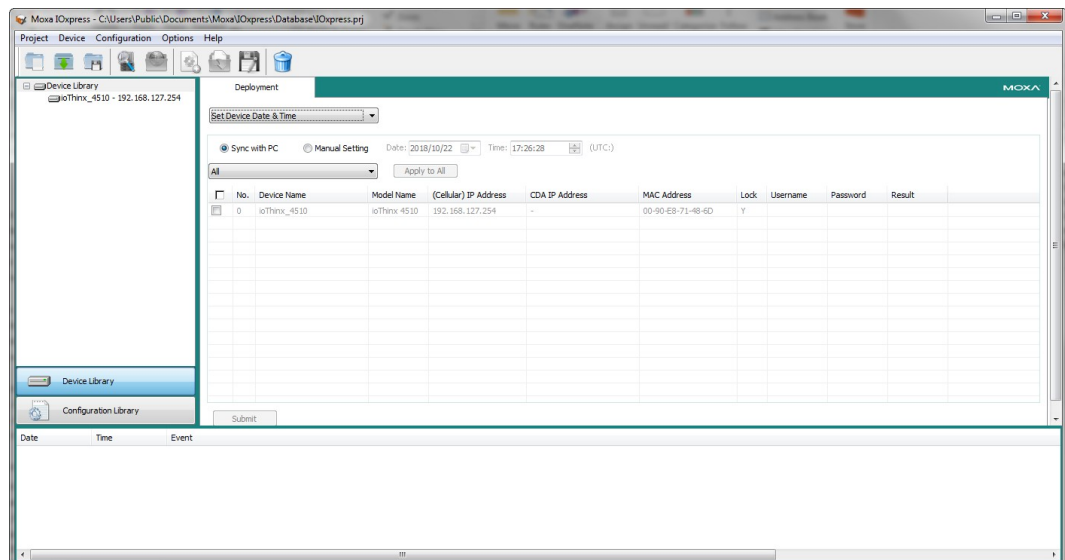

Changing IP Addresses to Multiple Devices

IOxpress supports changing IP addresses for multiple devices:

Step 1: Select **Change IP Address** in the dropdown button list.

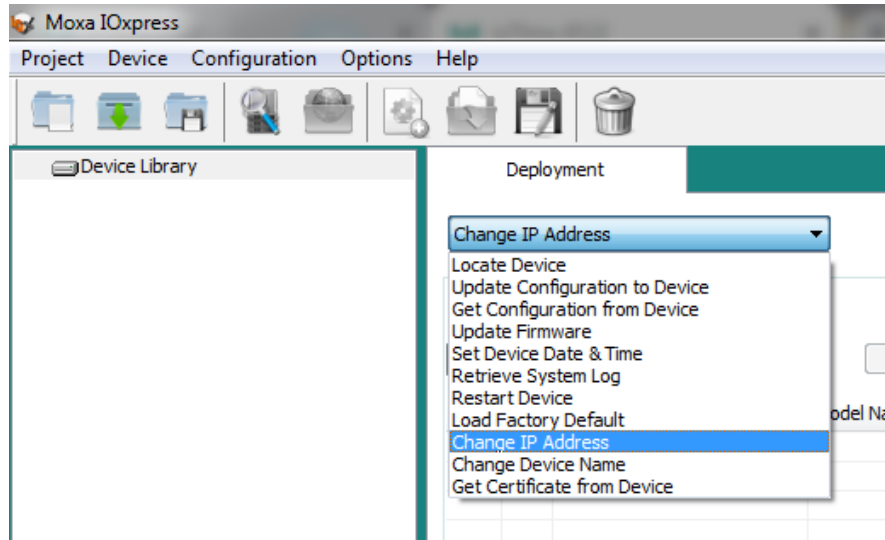

Step 2: Select the device(s), change the IP address, type the **username** and **password**, and then click **Submit**. IOxpress will execute the task on the selected devices. A message showing success will appear in the **Result** column if the process was completed successfully.

Changing the Device Name of Multiple Devices

IOxpress supports changing the device name of multiple devices:

Step 1: Select **Change Device Name** from the dropdown list.

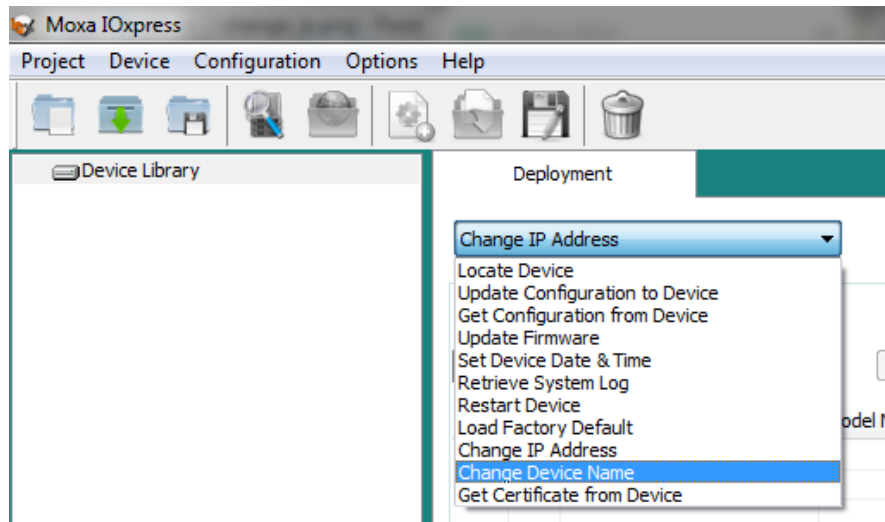

Step 2: Select the device(s), change the device name, type the **username** and **password**, and then click **Submit**. IOxpress will execute the task on the selected devices. A message showing success will appear in the **Result** column if the process was completed successfully.

Retrieving the System Log From Multiple Devices

IOxpress supports retrieving the system log from multiple devices.

Step 1: Select **Retrieve System Log** from the dropdown list.

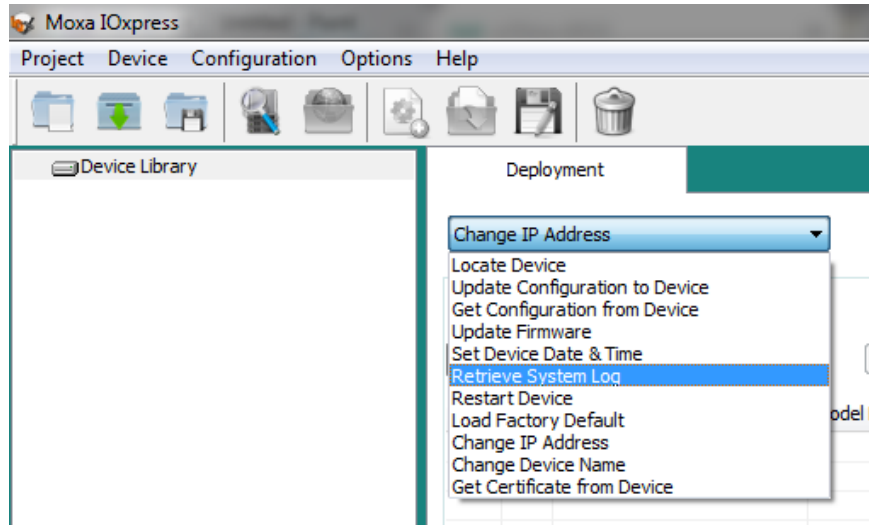

Step 2: Specify the folder location.

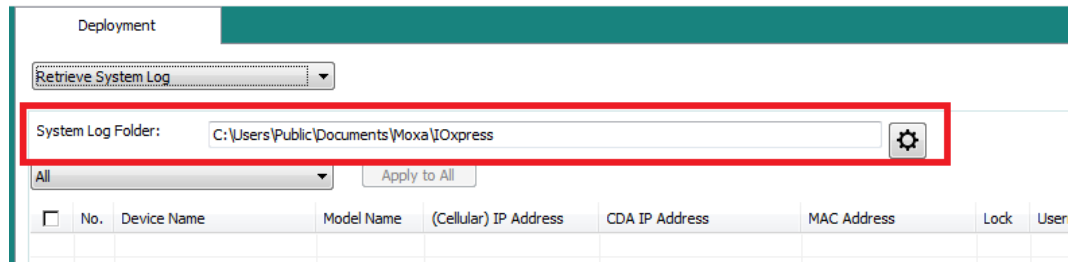

Step 3: Select the device(s), type the **username** and **password**, and then click **Submit**. IOxpress will execute the task on the selected devices. A message indicating success will appear in the **Result** column if the process is completed successfully.

Getting a Self-signed Certificate From Multiple Devices

IOxpress supports getting self-signed certificates from multiple devices.

Step 1: Select **Get Certificate from Device** from the drop-down list.

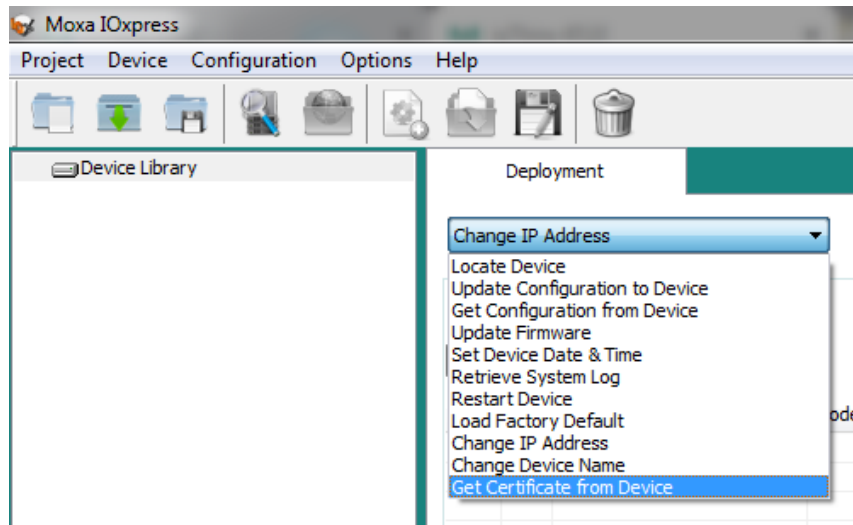

Step 2: Specify the folder location.

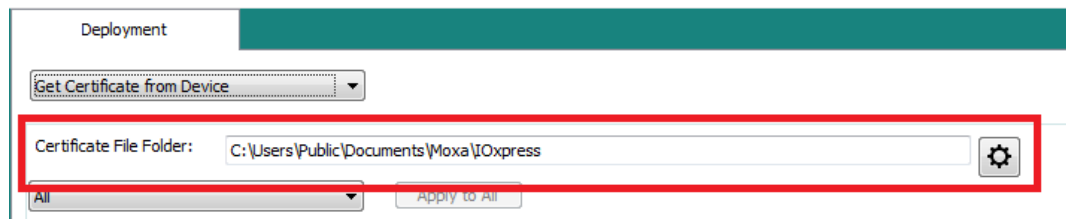

Step 3: **Step 3:** Select the device(s), type the **username** and **password**, and then click **Submit**. IOxpress will execute the task on the selected devices. A message showing success will appear in the **Result** column if the process is completed successfully.

Monitoring and Operating the Unit

To monitor and operate the device, go to the **Dashboard** of the Web Console.



INFORMATION

The ioThinX 4510 Series supports three different user profiles (Administrator, Operator, and User). Refer to [User Settings](#) for the permission information of each profile.



NOTE

For the device with firmware v1.3 and before, the HTTPS web service can only be used for configuration purposes; it cannot be used to monitor or operate the unit.

Monitoring Module & I/O Status

Under the **Dashboard** of the web console, click **Module & I/O** to go to the module and I/O status web page.

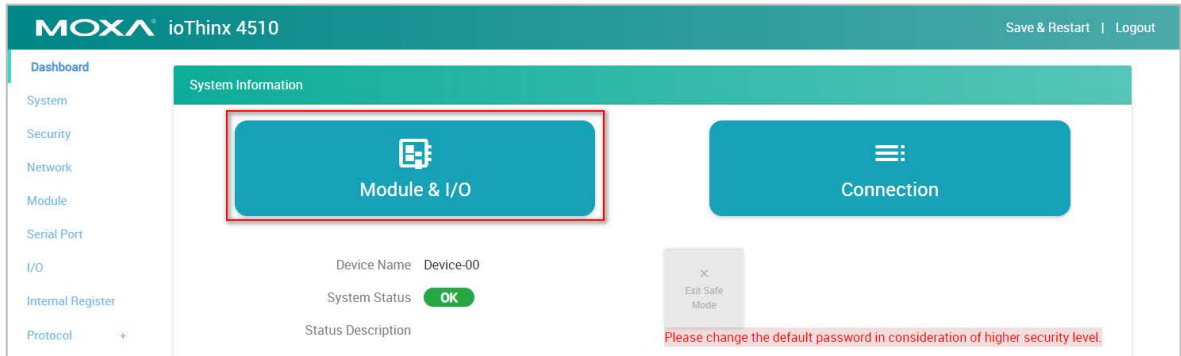

The upper side of this page shows the module status, including **Slot** position, module **Status**, **Firmware Version**, **Module Name**, **Model Name**, and **Serial Number**. Click **Locate** to identify the physical location of the module. The module's LED will blink green.

The lower side of the page shows the I/O status and allows you to operate the status of the output channels, such as DO, Pulse, or Relay channels. Refer to the [Module & I/O](#) section for detailed information.

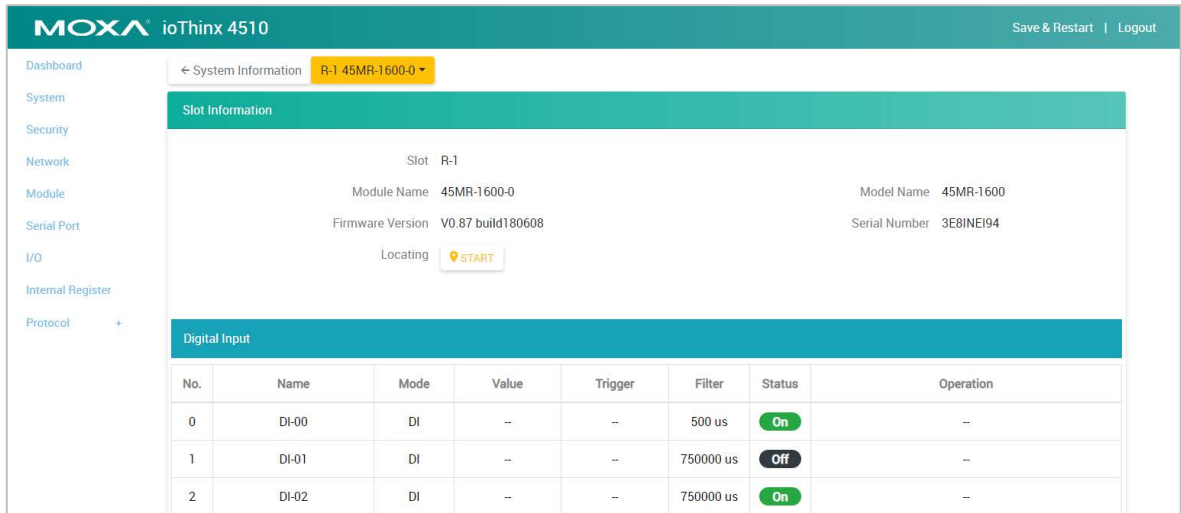

Monitoring Connection Status

Under the **Dashboard** of the web console, click the **Connection** button to go to the connection status web page.



The connection status page lists the connection information from other hosts.

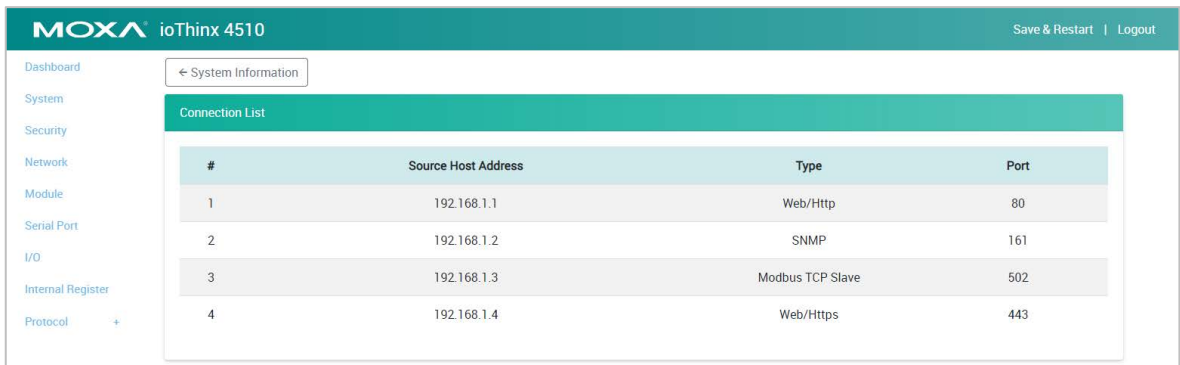

NOTE

Some browsers may create more than one Web HTTP/HTTPS connection at the beginning. Once the connection is established, the browsers will only keep one and drop the others. Thus, it is normal that more than one Web HTTP/HTTPS connection is listed in the table at the beginning.

Exiting Safe Mode Status

This device has a watchdog service to monitor the status of the predefined TCP connection (refer to [Account Settings](#) for detailed settings). If the predefined TCP connection has no response for a designated period, the device will enter the safe mode status. To exit safe mode status, if the auto clear safe mode is disabled in the watchdog settings, log in to the device's web console and click the **Exit Safe Mode** button to revert the device back to normal mode after the Modbus connection has reconnected.

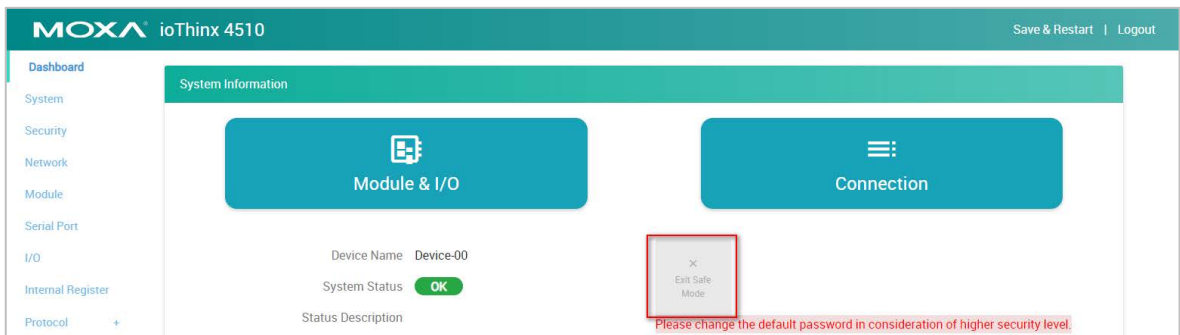

Maintaining the Unit

This section introduces the maintenance functions of the ioThinX 4510 Series.

Backing up Configuration Files

This device can only be configured through the web console. After configuration, the configuration file can be retrieved from the device to perform backup and mass deployment. Follow the steps to retrieve the configuration file from the device.

Step 1: Go to the configuration page via **Menu > System > Configuration**

Step 2: Click **Download** from **Get from Device** and choose the location to save the .cfg file.

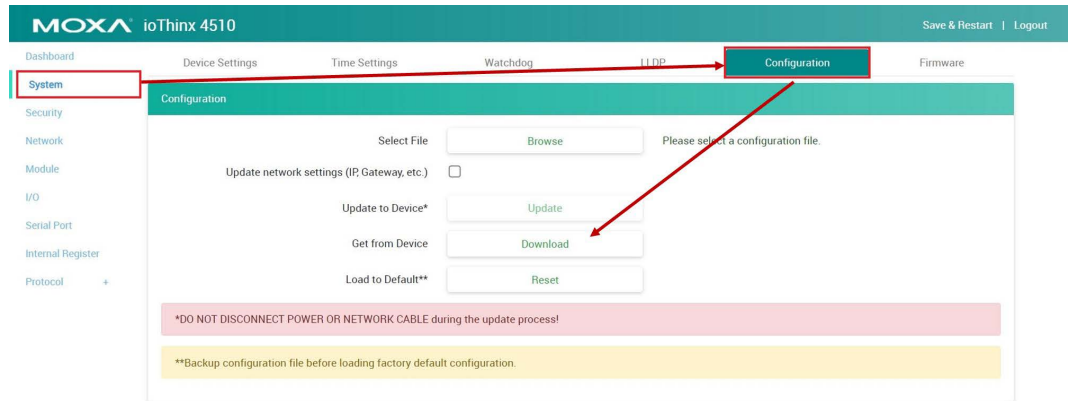

Updating the Firmware

Follow the steps to update the firmware to the device.

Step 1: Go to the configuration page via **Menu > System > Firmware**

Step 2: Click the **Browse** button to select a firmware file to update

Step 3: Click the **Update** button to start the update process

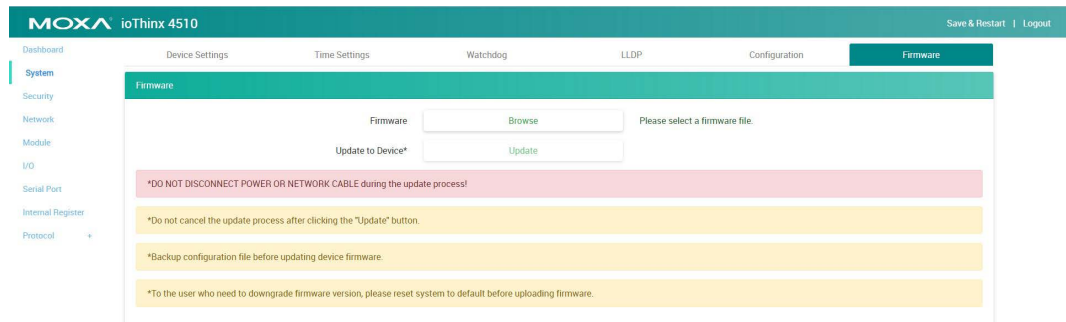

NOTE

When the device is updating, do not turn the power off as it might corrupt the device.



NOTE

The firmware cannot be updated via HTTPS. For those users who have security concerns, we suggest to use the manageability utility, IOxpress, to update firmware.



NOTE

Performing a firmware update will delete the configurations in the device. Back up the configurations before performing the firmware update.

Restarting the Unit

This device will restart automatically after the firmware and configurations have been updated. The user can also restart the device manually.

Step 1: Click **Save & Restart** on the right upper corner of the page.



Step 2: The device will confirm that you want to perform a restart. Click **Restart Device** to restart the device.

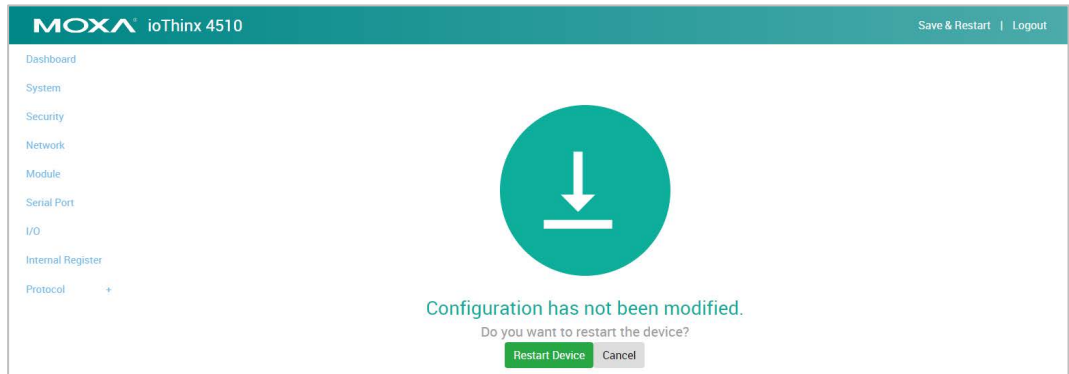

INFORMATION

This device does not have a battery. Therefore, if the device is powered off, the system date and time will have to be set again. If the NTP server is not available, set the date and time of the device after rebooting.

Loading Factory Default Settings

There are three ways to restore the device to factory default settings.

1. Follow the steps to load the factory default settings from the web console.
 - a. Go to the configuration page via **Menu > System > Configuration**
 - b. Click **Reset** located under **Load to Default** and then the device will return to default settings.

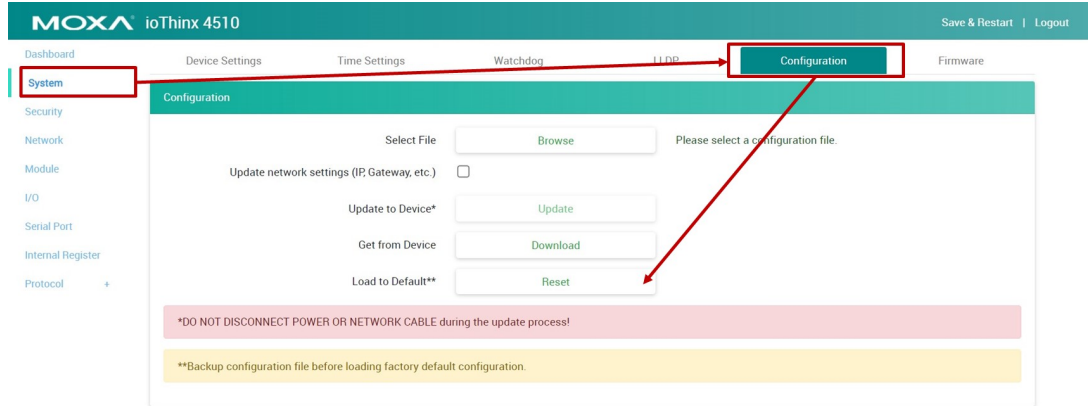

NOTE

Loading the factory default settings will delete the configurations from this device. Please back up the configurations before loading the factory default settings.

2. Follow the steps to load the factory default settings from IOxpress.
 - a. Select **Load Factory Default** from the dropdown menu.

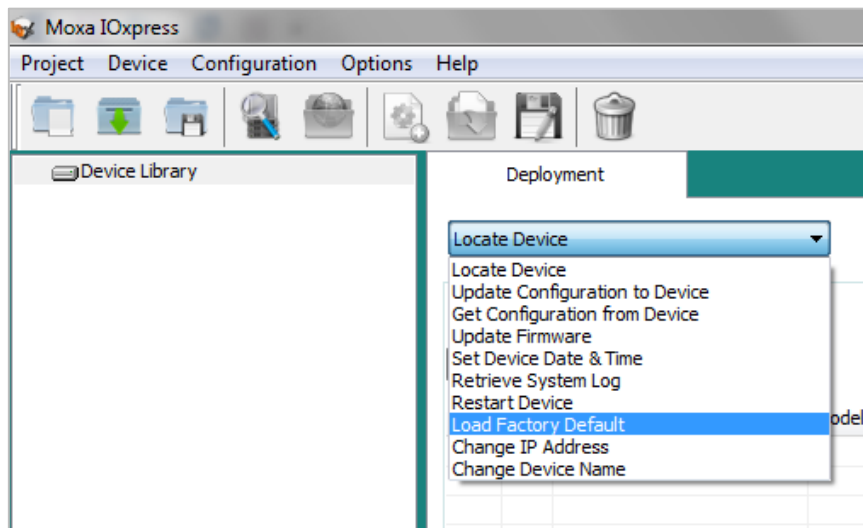

- b. Select the device(s), type the **username** and **password**, and then click **Submit**. IOxpress will perform the task on the selected devices. A message showing success will appear in the **Result** column when the process has been completed.



INFORMATION

Click **Apply to All** if the selected devices have the same settings.

3. Hold down the RESET button for 10 seconds to load factory default settings. The system will load the default settings and then restart the device. The system is ready when the RDY LED turns green.

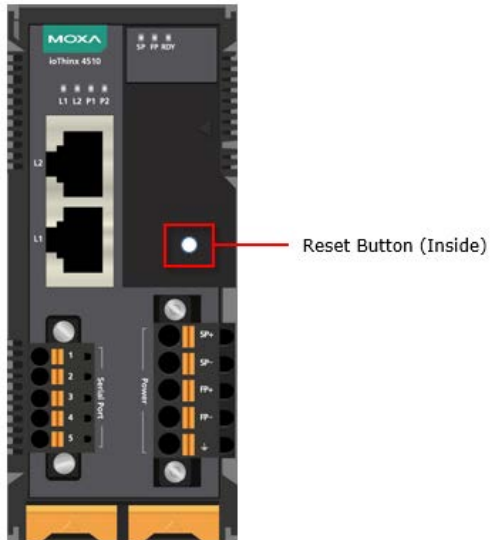

How to Use Modbus TCP to Connect to the ioThinx 4510 Series

Using Modbus TCP via Modbus Poll

Introduction to Modbus Poll

Please refer to the following web page for information about Modbus Poll:

https://www.modbustools.com/modbus_poll.html



Modbus Poll
IP address: 192.168.127.200

Modbus TCP

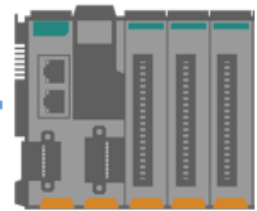

Moxa ioThinx 4510
IP address: 192.168.127.254

Enable Modbus/TCP Slave Service on the ioThinx 4510

1. Log in to the ioThinx 4510
 - a. Open your web browser and type the default IP address of the device: 192.168.127.254.
 - b. On the login page, type the default username/password (admin/moxa) to log in to the Web Console.
2. Enable Modbus/TCP slave service.

The screenshot shows the Moxa ioThinx 4510 web console interface. The 'Service Settings' tab is selected, displaying a table of services. The 'Modbus/TCP Slave' service (No. 6) is highlighted with a red box. A red warning message is visible above the table: 'MUST import the self-signed certificate before enabling the web service via https, or the browsers may block the connection'.

No.	Service	TCP/UDP	Port
<input checked="" type="checkbox"/> 1	Web Service via HTTP	TCP	80
<input type="checkbox"/> 2	Web Service via HTTPS	TCP	443
MUST import the self-signed certificate before enabling the web service via https, or the browsers may block the connection			
<input checked="" type="checkbox"/> 3	RESTful API via HTTP	TCP	80
<input checked="" type="checkbox"/> 4	RESTful API via HTTPS	TCP	443
<input type="checkbox"/> 5	SNMP Agent	UDP	161
<input checked="" type="checkbox"/> 6	Modbus/TCP Slave	TCP	502

- Click **Save & Restart** in the top right of the page and then click **Save and Restart** in the center of the page.

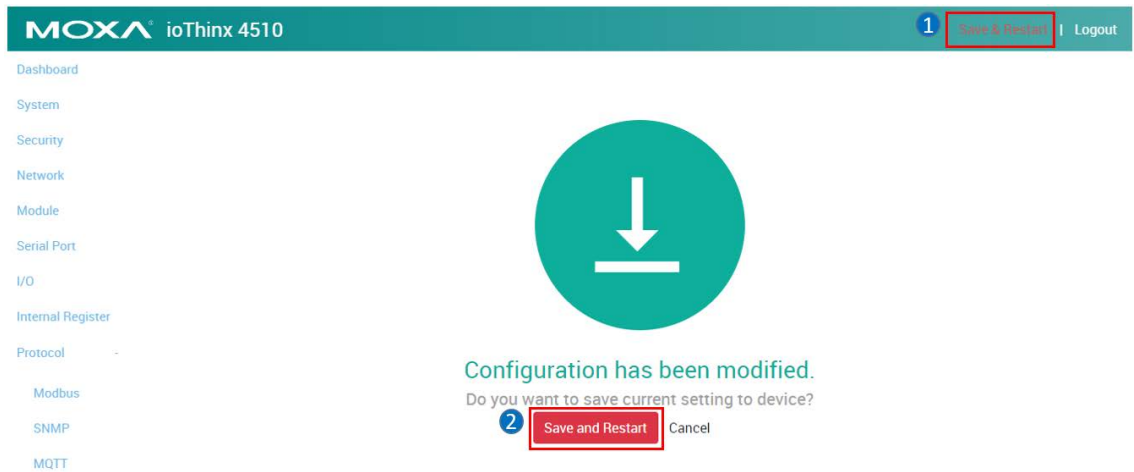

Set Up a Connection on Modbus Poll

- Select **Connect** on **Modbus Poll's Connection** panel.

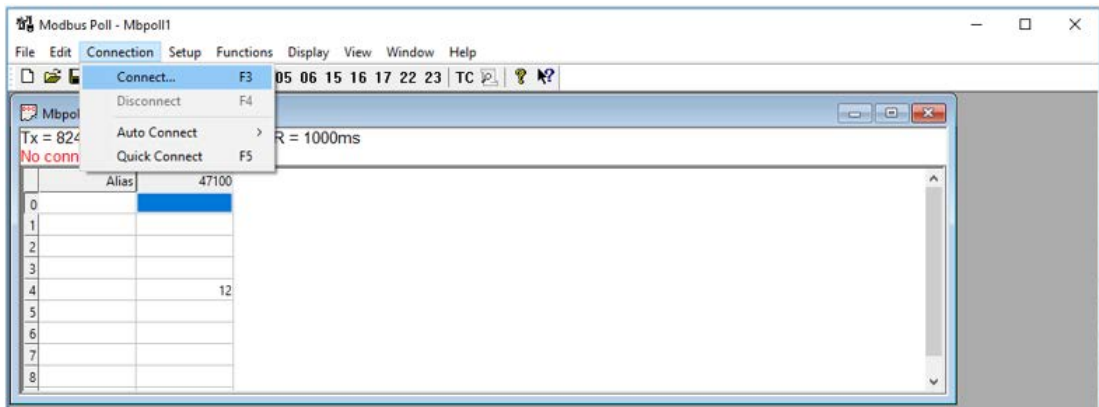

- Enter the IP address of the device (default IP: 192.168.127.254).

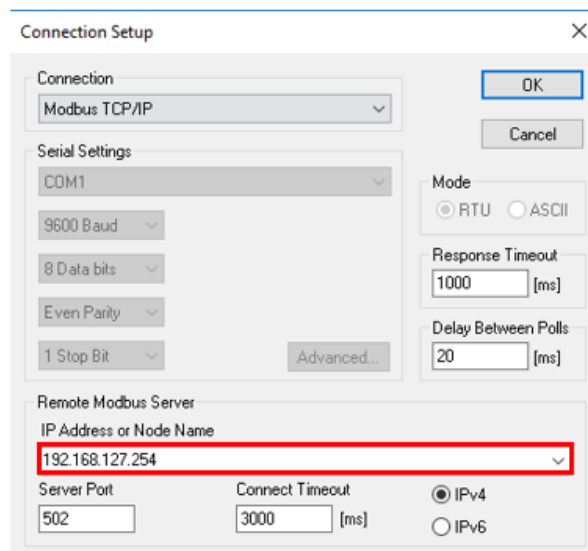

Write Single Coil: Use Modbus Poll to Turn On an ioThinx 4510 DO Channel

1. Select **Read/Write Definition** under the **Setup** menu.

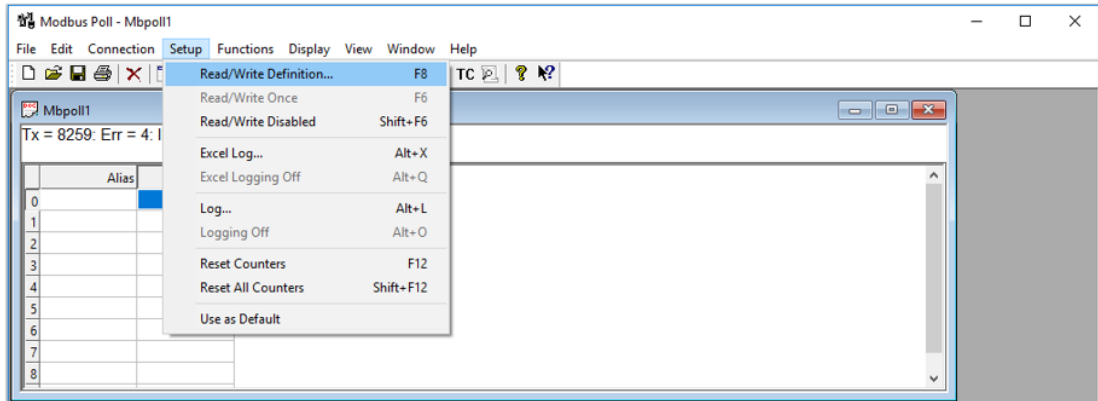

2. Select the **function** code **05 Write Single Coil** and then enter **0**, the start **Address** of the DO channel.

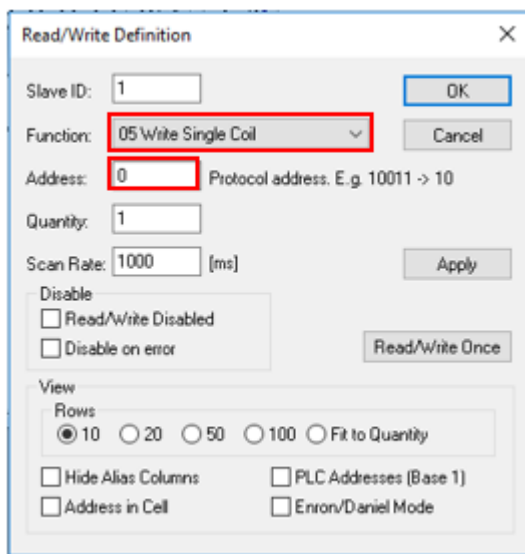

NOTE

Take the following steps to check the Start Address of the device in the web console.

1. Open the web console and then click **Modbus** in the left panel. On this page, the Modbus TCP addresses are categorized as **Coil Status**, **Input Status**, **Holding Register**, and **Input Register**.

MOXA ioThinx 4510				Filter	Save & Restart	Logout		
				01: Coil Status (R/W)	02: Input Status (R)	03: Holding Register (R/W)	04: Input Register (R)	
#	Slot	Module Name	Parameter	Point Type	Start Address (DEC)	Start Register (DEC)	Length	Data Type
1	R-02	45MR-2600-0	doStatus	01	0	000001	16	BOOL
2	R-00	ioThinx4510	birValue	01	2560	002561	64	BOOL

- Type the text "doStatus" in the filter to find the **Start Address** of the DO channel.

MOXA ioThinX 4510

Modbus TCP Slave

Service Enabled Note: enable/disable this service through Security>Service Settings

Filter: doStatus

#	Slot	Module Name	Parameter	Point Type	Start Address (DEC)	Start Register (DEC)	Length	Data Type
1	R-02	45MR-2600-0	doStatus	01	0	000001	16	BOOL



NOTE

You can also manually change the addresses if needed. To do so, click Save & Restart in the top right of the page after changing the Start Address.

MOXA ioThinX 4510

Filter Save & Restart Logout

#	Slot	Module Name	Parameter	Point Type	Start Address (DEC)	Start Register (DEC)	Length	Data Type
1	R-02	45MR-2600-0	doStatus	01	0	000001	16	BOOL
2	R-00	ioThinX4510	birValue	01	2560	002561	64	BOOL
3	R-03	45MR-3810-0	aiResetMinValue	01	36608	036609	8	BOOL
4	R-03	45MR-3810-0	aiResetMaxValue	01	37632	037633	8	BOOL
5	R-01	45MR-1600-0	diCounterStatus	01	42240	042241	4	BOOL

- Change the DO-00 value from 0 to 1; DO-00 will respond by turning on the LED.

Modbus Poll - Mbpoll1

Tx = 112; Err = 0; ID = 1; F = 05; SR = 1000ms

Alias	Value
0	00000
1	
2	
3	
4	
5	
6	
7	

Read Coils: Use Modbus Poll to Read the ioThinx 4510 DO Channel Status

1. Select **Read/Write Definition** in the **Setup** panel.
2. Select the **function** code **01 Read Coils** and enter **0**, the start **Address** of the DO channel.

Read/Write Definition

Slave ID: 1

Function: 01 Read Coils (0x)

Address: 0 Protocol address. E.g. 11 -> 10

Quantity: 10

Scan Rate: 1000 [ms]

Disable

Read/Write Disabled

Disable on error

Read/Write Once

View

Rows

10 20 50 100 Fit to Quantity

Hide Alias Columns PLC Addresses (Base 1)

Address in Cell Enron/Daniel Mode

3. The status will be shown in the table; when the DO-00 channel is turned on, the value should be 1).

Modbus Poll - Mbpoll1

File Edit Connection Setup Functions Display View Window Help

05 06 15 16 17 22 23 TC

Mbpoll1

Tx = 37: Err = 0: ID = 1: F = 01: SR = 1000ms

	Alias	00000
0		1
1		0
2		0
3		0
4		0
5		0
6		0
7		0
8		0

How to Use RESTful API to Connect to the ioThinX 4510 Series

Using RESTful API via Postman

Introduction to Postman

For information about Postman, please refer to the following web page: <https://www.getpostman.com/>. Step-by-step procedures on how to use Postman are described below.



Postman(RESTful API client)
IP address: 192.168.127.200

RESTful API

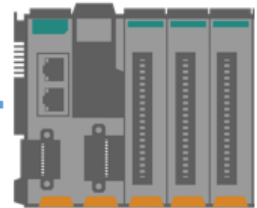

Moxa ioThinX 4510
IP address: 192.168.127.254

Enable the RESTful API Service on the ioThinX 4510

1. Log in to the ioThinX 4510
 - a. Open your web browser and type the default IP address of the device: 192.168.127.254.
 - b. On the login page, type the default username/password (admin/moxa) to log in to the Web Console.
2. Click **Security** in the left menu and then select **RESTful API via HTTP** Service Settings.

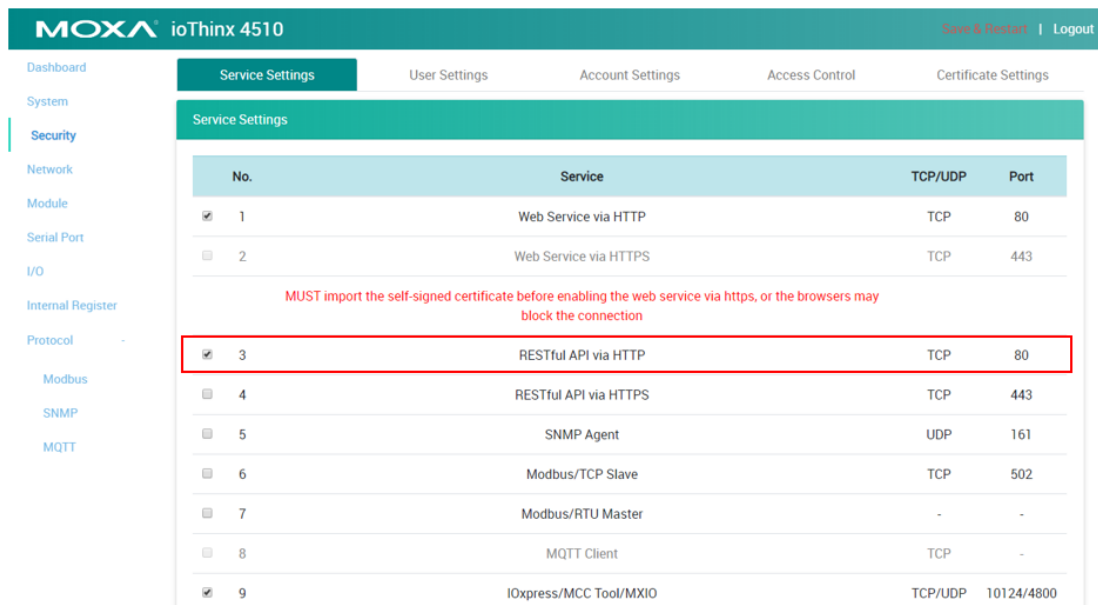

The screenshot shows the Moxa ioThinX 4510 Web Console interface. The left sidebar contains a menu with 'Security' selected. The main content area is titled 'Service Settings' and contains a table of services. The table has columns for 'No.', 'Service', 'TCP/UDP', and 'Port'. The row for 'RESTful API via HTTP' (No. 3) is highlighted with a red border. A red warning message is displayed above the table: 'MUST import the self-signed certificate before enabling the web service via https, or the browsers may block the connection'.

No.	Service	TCP/UDP	Port
<input checked="" type="checkbox"/> 1	Web Service via HTTP	TCP	80
<input type="checkbox"/> 2	Web Service via HTTPS	TCP	443
MUST import the self-signed certificate before enabling the web service via https, or the browsers may block the connection			
<input checked="" type="checkbox"/> 3	RESTful API via HTTP	TCP	80
<input type="checkbox"/> 4	RESTful API via HTTPS	TCP	443
<input type="checkbox"/> 5	SNMP Agent	UDP	161
<input type="checkbox"/> 6	Modbus/TCP Slave	TCP	502
<input type="checkbox"/> 7	Modbus/RTU Master	-	-
<input type="checkbox"/> 8	MQTT Client	TCP	-
<input checked="" type="checkbox"/> 9	IExpress/MCC Tool/MXIO	TCP/UDP	10124/4800

- Click **Save & Restart** in the top right corner of the page and then click Save and Restart in the center of the page.

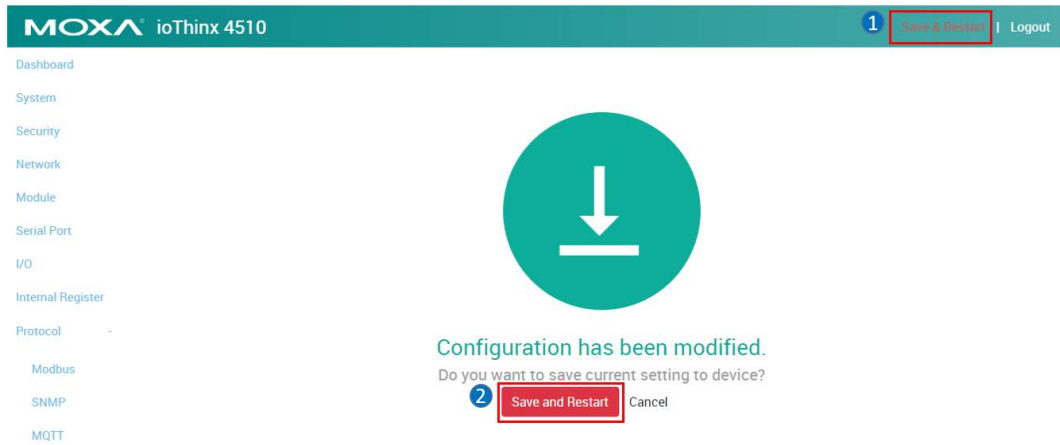

Configuring Postman

- Open Postman and create a new Request (named **GET example**).
- Create a **Collection**.
- Save** the new **Request** in the created **Collection**.
- Create another new **Request** (named **PUT example**) and save it in the created **Collection**.

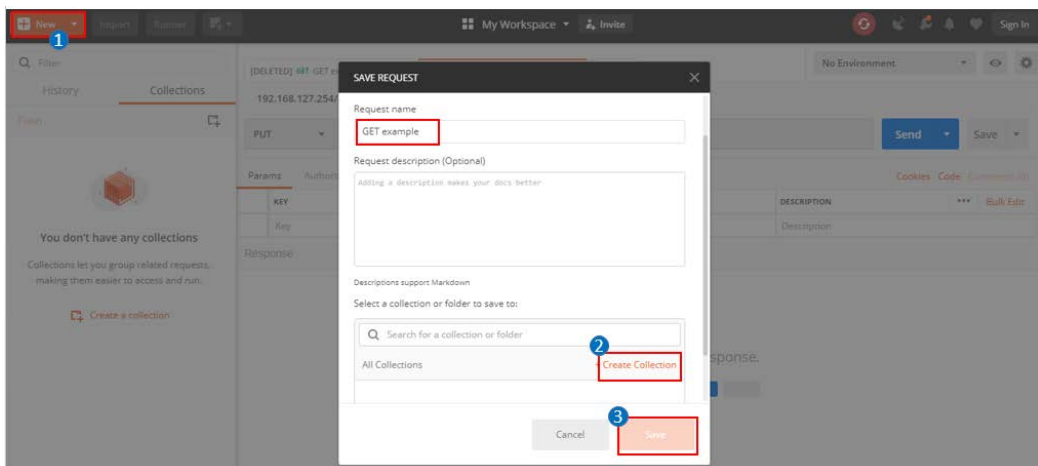

- Select the **GET method** on the **GET example** tab and select the **PUT method** on the **PUT example** tab.

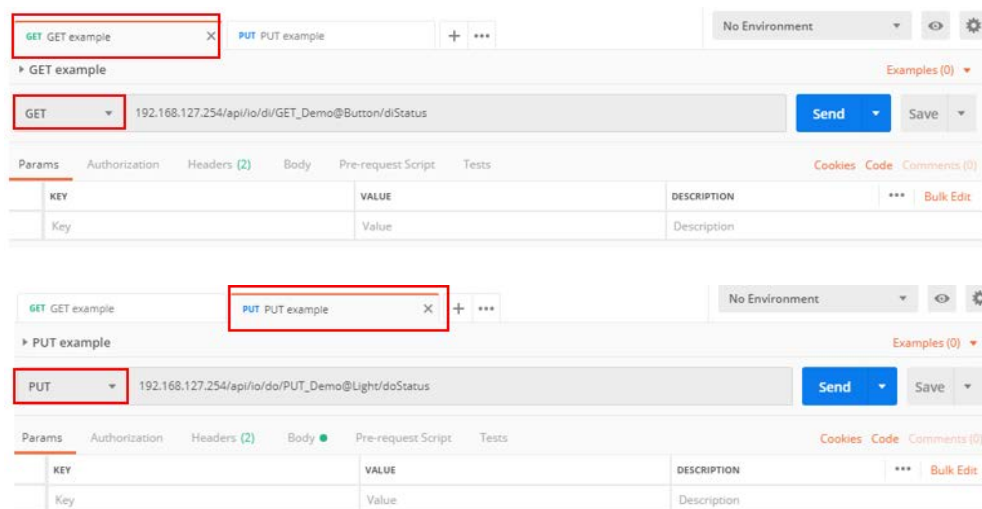

6. Create the following content in the Headers of the GET example tab and PUT example tab.
 - Content-Type: application/json
 - Accept: vdn.dac.v2

KEY	VALUE	DESCRIPTION
<input checked="" type="checkbox"/> Content-Type	application/json	
<input checked="" type="checkbox"/> Accept	vdn.dac.v2	

Send a GET Request and a PUT Request

RESTful API List Rules

You can check the RESTful API list here: [RESTful API Rules](#).

RESTful API	Description	Access	Format
/api/io/do{ioName}/doStatus	DO - status (0: OFF; 1: ON)	R/W	0 or 1
/api/io/do{ioName}/doPulseCount	DO - Pulse mode - count	R/W	0 to 65535
/api/io/do{ioName}/doPulseOnWidth	DO - Pulse mode - ON width (unit 500 μs)	R/W	1 to 65535
/api/io/do{ioName}/doPulseOffWidth	DO - Pulse mode - OFF width (unit 500 μs)	R/W	1 to 65535
/api/io/do{ioName}/doPulseStatus	DO - Pulse mode - status (0: Stop; 1: Start)	R/W	0 or 1

The {ioName} is composed of three elements: Module_Name, @, and I/O_Channel_Name. For example, the {ioName} associated with module name "45MR-2600-0" and DO channel name "DO-00" is 45MR-2600-0@DO-00.



NOTE

The module and I/O channel name can be changed in **Module Settings** and **I/O Settings**.

1. In this demonstration, we change the name of module **45MR-1601** to **GET_Demo** and the name of **45MR-2600** to **PUT_Demo**.

The screenshot shows the 'Module Settings' page for a MOXA ioThinX 4510 device. At the top, there's a header with 'MOXA ioThinX 4510' and 'Save & Restart | Logout'. Below the header, there's a 'Module' section. The main content area is titled 'Module Settings' and contains a 'Match' button with the instruction 'Click finish button to complete module settings.' Below this, there are 'Save Settings' and 'Cancel' buttons. The core of the interface is a table with three columns: 'Slot', 'Detected Module', and 'Configured Module'. The table has three rows:

Slot	Detected Module	Configured Module
1	45MR-1601 →	45MR-1601 GET_Demo
2	45MR-2600 →	45MR-2600 PUT_Demo
3	45MR-3810 →	45MR-3810 45MR-3810-0

 The 'GET_Demo' and 'PUT_Demo' entries in the 'Configured Module' column are highlighted with red boxes. There are also icons for deleting and editing each entry.

2. Change the **DI-00** channel name to **Button**.

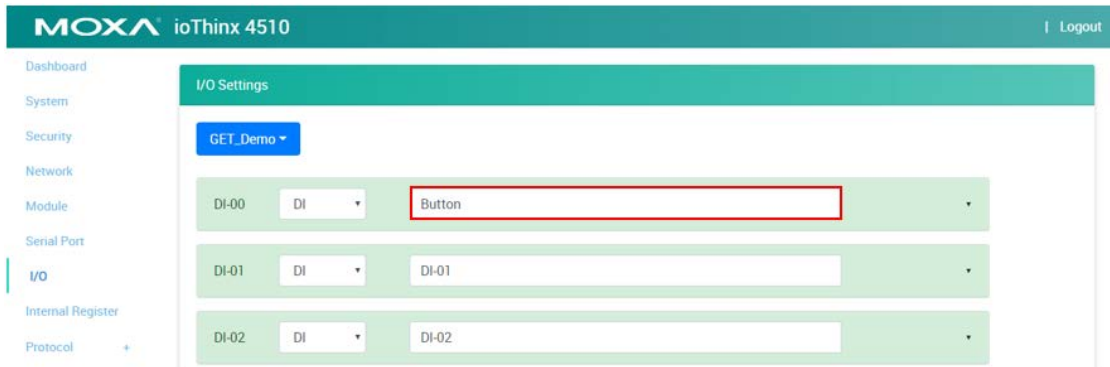

3. Change the **DO-00** channel name to **Light**.



Send a GET Request

1. Enter the request URL based on the IP address, file type, and API map. For this example, the request URL should be written as:
192.168.127.254/api/io/di/GET_Demo@Button/diStatus
2. Click the Send button. You should see the status code, response time, and results.

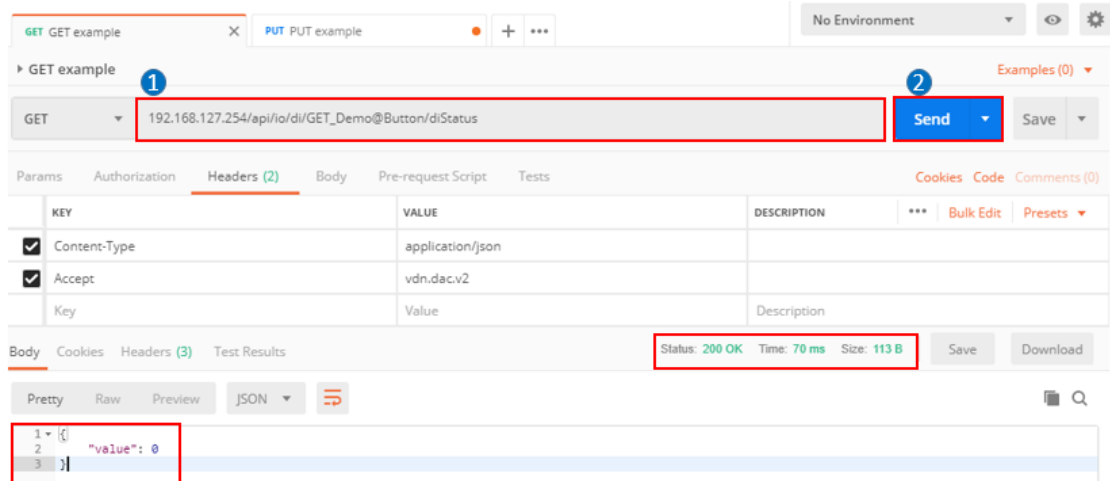

3. Press the DI0 button on the starter kit to trigger the DI-00 channel, and then click **Send** again. In response, the DI value will change.

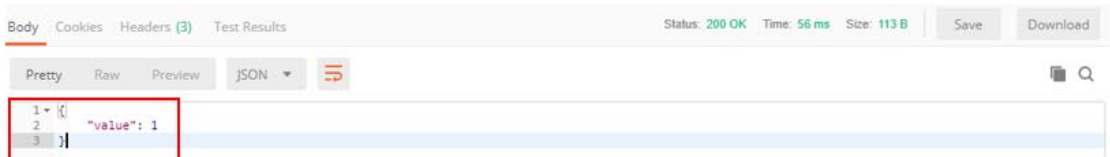

Send a PUT Request

1. Enter the following request URL:
192.168.127.254/api/io/do/PUT_Demo@Light/doStatus
2. Locate the Body tag, select raw, and choose the JSON format.
3. Enter the following message:

```
1 {  
2   "value": 1  
3 }
```

4. Click **Send**. The DO-00 channel should respond by turning the light on.

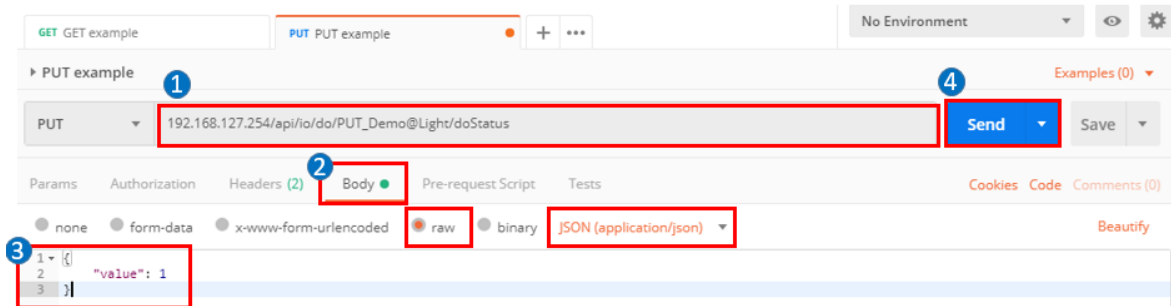

How to Use MQTT to Connect to the ioThinX 4510 Series

Broker Settings on the Computer

Introduction to Mosquitto

For information about Eclipse Mosquitto, please refer to the following web page: <https://mosquitto.org/>. Mosquitto can implement versions 5.0, 3.1.1, and 3.1 of the MQTT protocol.



Host
IP address: 192.168.127.200

Moxa ioThinX 4510
IP address: 192.168.127.254

Run Mosquitto Broker From Task Manager

Type **Ctrl + Alt + Delete** to open **Task Manager**, click the **mosquitto** row to select it, and then right click in the status column and select **Start**.

Set Up MQTT on the ioThinX 4510

Enable MQTT Client Service

1. Log in to the ioThinX 4510:
 - a. Open your web browser and type the default IP address of the device: 192.168.127.254.
 - b. On the login page, type the default username/password (admin/moxa) to log in to the Web Console.
2. Click Security in the left menu. Select Service Settings at the top of the page and then select MQTT Client.

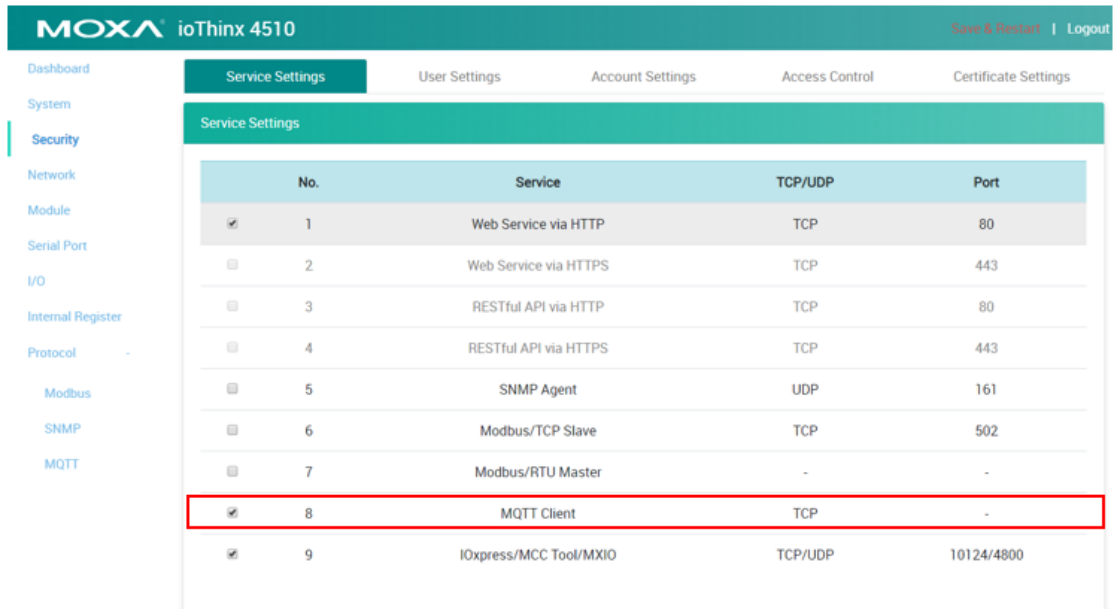

Connection and Topic Settings

1. Select **MQTT** in the left menu and then set the **Broker IP** (your host's IP) under **Connection Settings**.

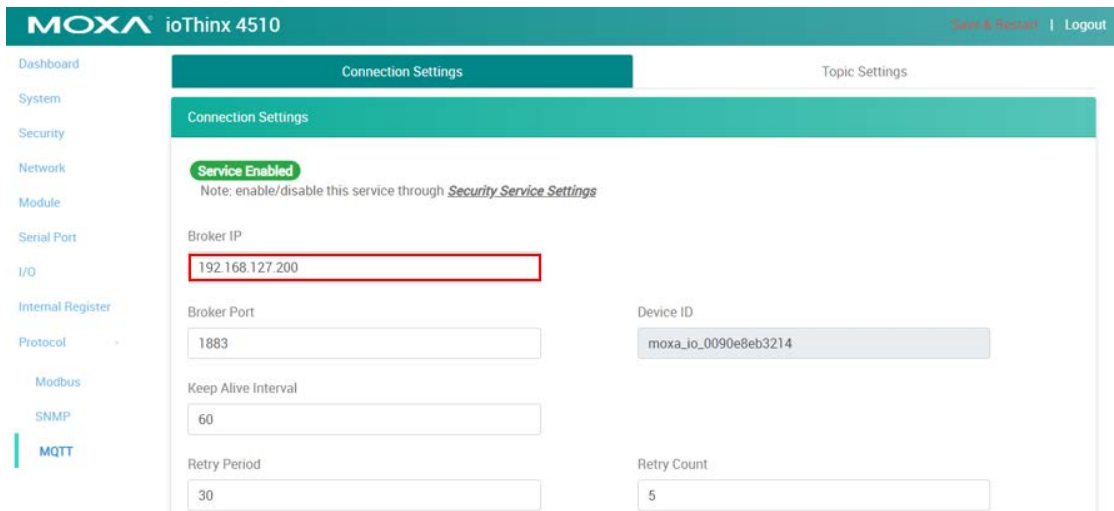

- Click **Publisher** and enable **Topic#1 (DI-00)**, and then click **Subscriber** and enable **Topic#1 (DO-00)**.

The screenshot shows the MOXA ioThinx 4510 web interface. The 'Topic Settings' page is displayed with the 'Publisher' tab selected. The 'Batch Edit' section shows 'Enable' as 'ON' and 'Retained' as 'OFF'. The 'Trigger' section shows 'Interval' set to 5 and 'On Change' set to 50. The table below shows two entries:

#	Enable	Slot	Channel	Topic	QoS	Retained	Trigger	Condition
1	<input checked="" type="checkbox"/>	R-01	DI-00	Tutorial/read/GET_Demo@Button/diStatus	0	<input type="checkbox"/>	On Change	- (Unit: %)
2	<input type="checkbox"/>	R-01	DI-01	Tutorial/read/GET_Demo@DI-01/diStatus	0	<input type="checkbox"/>	On Change	- (Unit: %)

The screenshot shows the MOXA ioThinx 4510 web interface. The 'Topic Settings' page is displayed with the 'Subscriber' tab selected. The 'Batch Edit' section shows 'Enable' as 'ON' and 'Retained' as 'OFF'. The table below shows two entries:

#	Enable	Slot	Channel	Topic	QoS
1	<input checked="" type="checkbox"/>	R-02	DO-00	Tutorial/write/PUT_Demo@Light/doStatus	0
2	<input type="checkbox"/>	R-02	DO-01	Tutorial/write/PUT_Demo@DO-01/doStatus	0



NOTE

The content of the **Topic** is based on **Device Name**, **Module name**, and **I/O channel**. You can change these values in **Device Settings**, **Module Settings**, and **I/O Settings**.

MOXA ioThinx 4510 Save & Restart | Logout

Dashboard | System | Security | Network | Module | Serial Port | I/O | Internal Register | Protocol +

Device Settings | Time Settings | Watchdog | Configuration | Firmware

Device Settings

Device Name: Tutorial

Language: English

MOXA ioThinx 4510 Save & Restart | Logout

Module

Module Settings

Match Click finish button to complete module settings.

Save Settings | Cancel

Slot	Detected Module	Configured Module
1	45MR-1601 →	45MR-1601 PUB_Demo
2	45MR-2600 →	45MR-2600 SUB_Demo
3	45MR-3810 →	45MR-3810 45MR-3810-0

MOXA ioThinx 4510 Save & Restart | Logout

Dashboard | System | Security | Network | Module | Serial Port | I/O | Internal Register | Protocol +

I/O Settings

PUB_Demo

DI-00 DI Button

DI-01 DI DI-01

DI-02 DI DI-02

In this demonstration, we changed our **Topic #1 (DI-00 and DO-00)** as below:
Publisher **Topic#1**(DI-00):Tutorial/read/PUB_Demo@Button/diStatus.
Subscriber **Topic#1**(DO-00):Tutorial/write/SUB_Demo@Light/doStatus.

- Click **Save & Restart** in the upper-right corner, and then click **Save and Restart** in the center of the page.

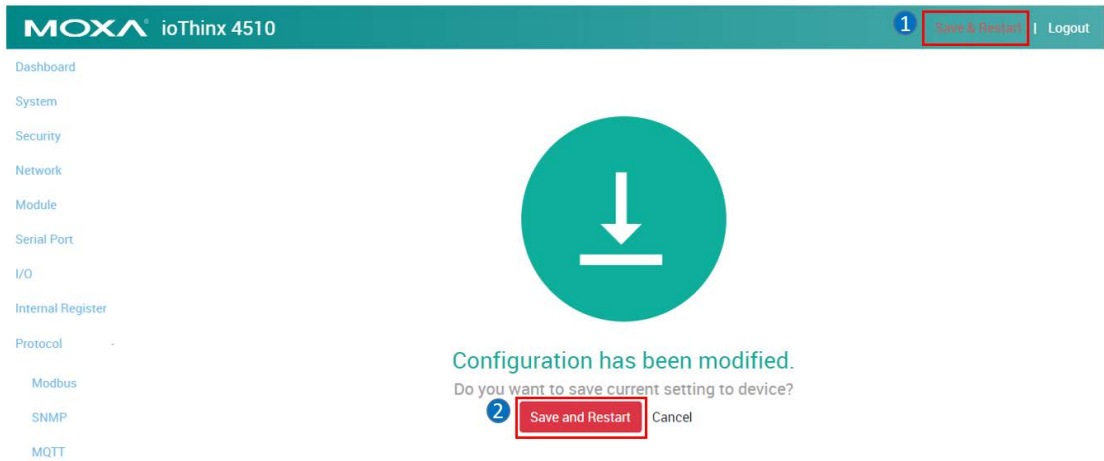

Publisher and Subscriber Settings

Introduction to MQTTLens

MQTTLens is a chrome application that supports MQTT communications. MQTTLens can be used to simulate communicating with the ioThinx 4510 via MQTT.

Configuring MQTTLens

- Add a new connection on **MQTTLens**



- Enter your **Connection name** and **Hostname** (broker IP) in the associated text input boxes.

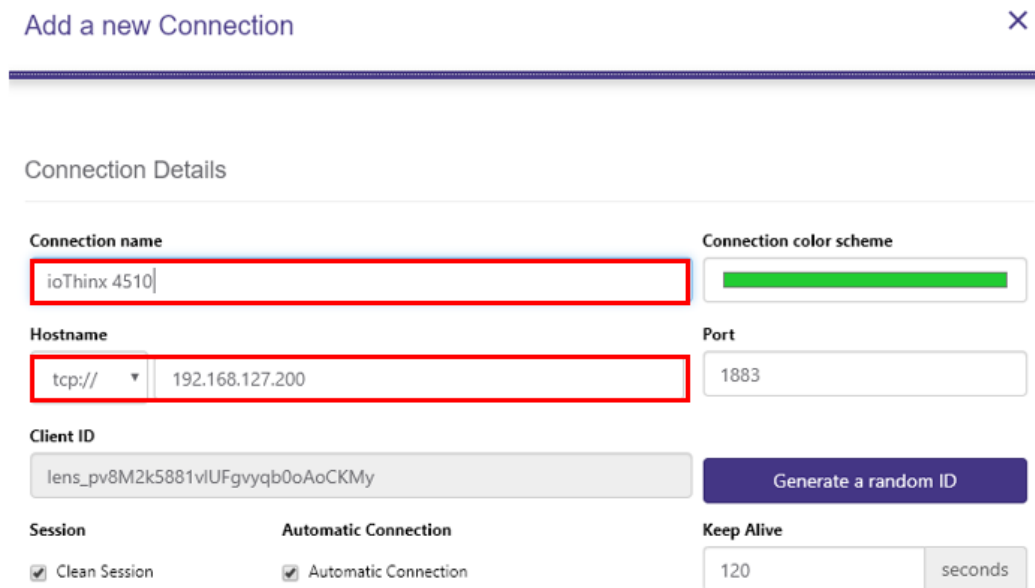

Scenario 1: Publish DI Status to MQTTlens

- Publisher: ioThinx 4510
 - Subscriber: MQTTlens
1. Copy the topic from the ioThinx 4510 **MQTT publisher** tab.

Publisher					Subscriber			
#	Enable	Slot	Channel	Topic	QoS	Retained	Trigger	Condition
1	<input checked="" type="checkbox"/>	R-01	DI-00	Tutorial/read/PUB_Demo@Button/diStatus	0	<input type="checkbox"/>	On Change	(Unit: %)

Paste the topic into the subscribe column of the MQTTlens, and then click subscribe.

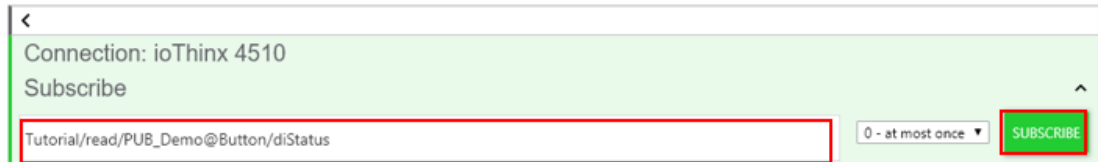

2. Press the DI0 button on the starter kit to trigger the DI-00 channel; you should see the DI value change on your subscriber.



Scenario 2: Turn On ioThinx 4510's DO Channel

- Publisher: MQTTlens
 - Subscriber: ioThinx 4510
1. Copy the topic from the ioThinx 4510 **MQTT subscriber** page.

Publisher					Subscriber	
#	Enable	Slot	Channel	Topic	QoS	
1	<input checked="" type="checkbox"/>	R-02	DO-00	Tutorial/write/SUB_Demo@Light/doStatus	0	

2. Paste the Topic into the MQTTlens publish column.
3. Enter the following message:
Message
{
 "value":1
}
4. Click **Publish**. The DO-00 channel should respond by turning the light on.

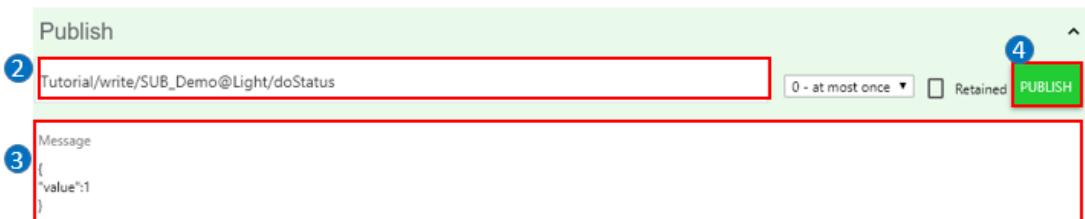

How to Connect ioThinx 4510 to an MQTT Broker over TLS

When using MQTT over TLS, the broker should support the following encryption method, which is supported by ioThinx 4510.

- MBEDTLS_TLS_ECDHE_ECDSA_WITH_AES_128_GCM_SHA256
- MBEDTLS_TLS_ECDHE_ECDSA_WITH_AES_128_CBC_SHA256

Broker Settings on the Computer

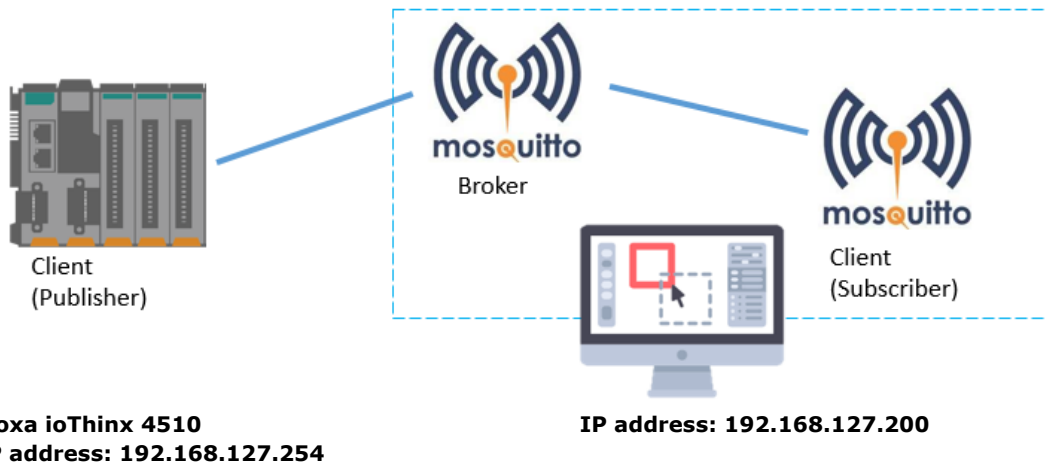

Install OpenSSL

OpenSSL is a full-featured toolkit for the Transport Layer Security (TLS) and Secure Sockets Layer (SSL) protocols. You will need this for generating the key.

1. Download and install OpenSSL from the website: <https://www.openssl.org/source/>
2. Set the environment variables to function OpenSSL properly on your system.

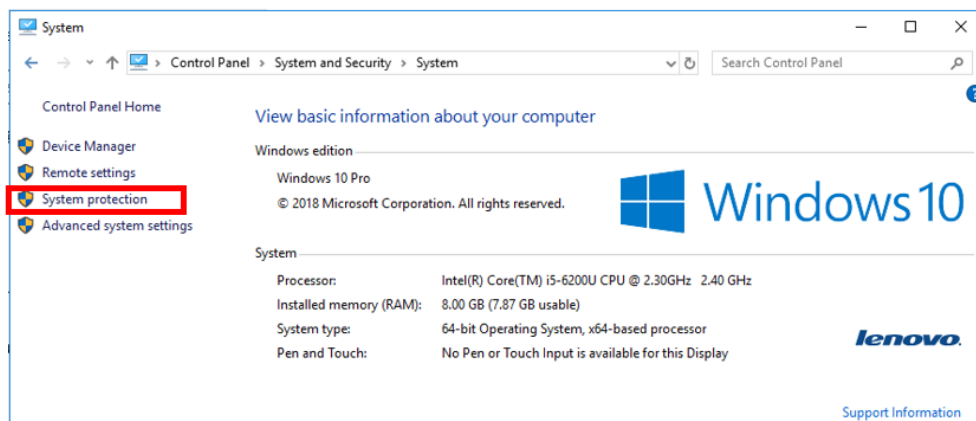

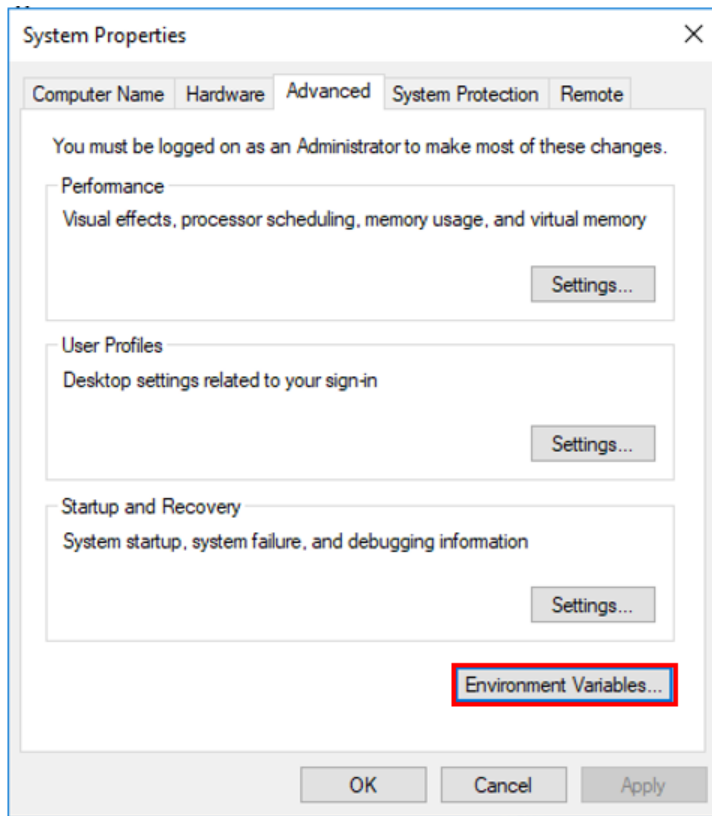

3. Select Path and click edit in the user variables section.

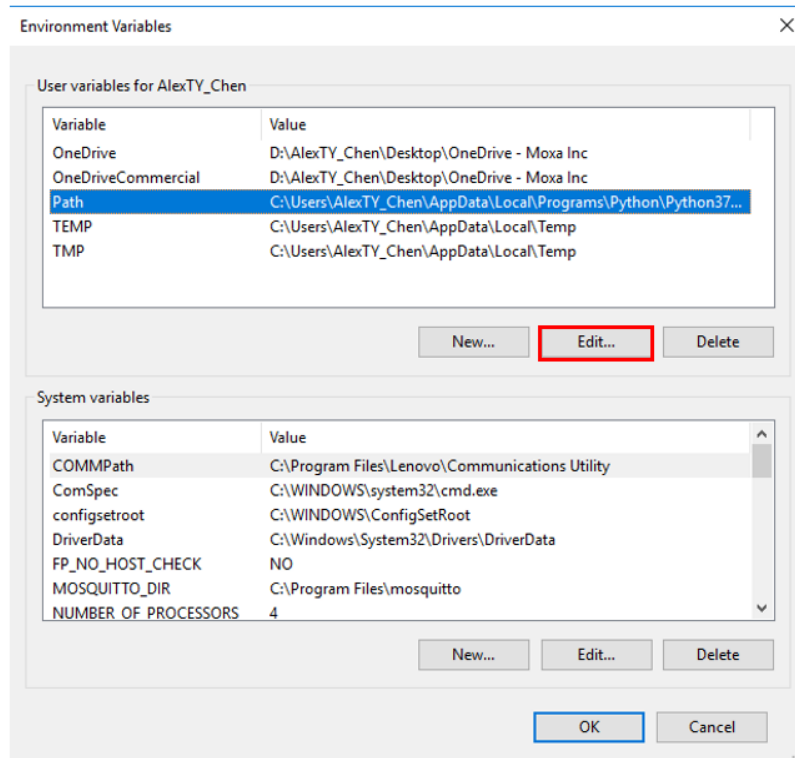

4. Create a new path for OpenSSL.

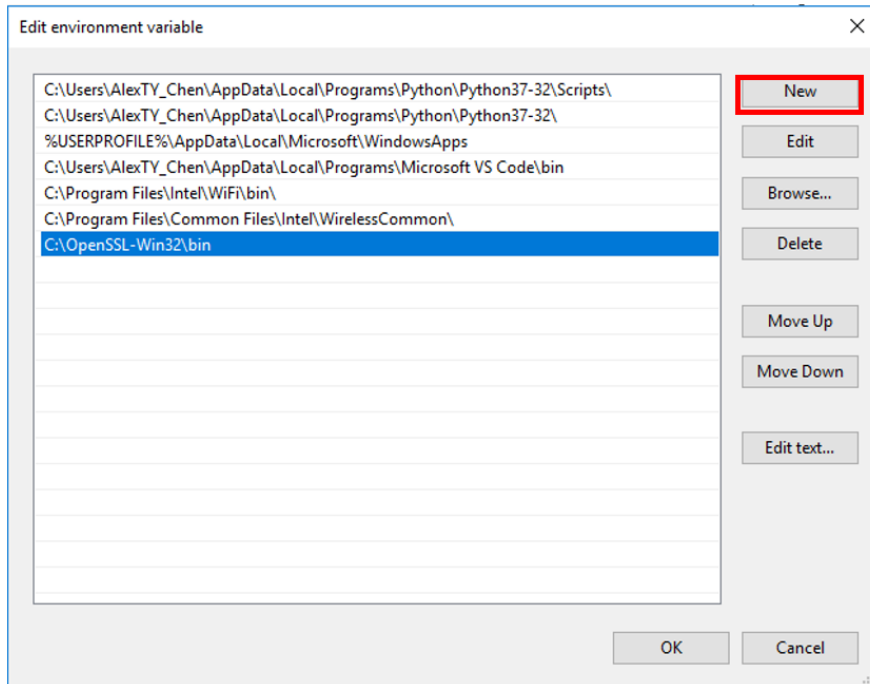

Generate Certificate

1. Run CMD (Command Prompt) as administrator
2. Generate certificate for the broker by entering below commands in cmd:
 - openssl ecparam -name prime256v1 -genkey -noout -out key.pem
 - openssl req -x509 -nodes -new -key key.pem -out ca.crt
 - openssl req -new -key key.pem -out certificate.csr
 - openssl x509 -req -in certificate.csr -CA ca.crt -CAkey key.pem -CAcreateserial -out certificate.crt



NOTE

The **Common Name** should be broker IP.

```
Administrator: Command Prompt
C:\Program Files\mosquitto>openssl ecparam -name prime256v1 -genkey -noout -out key.pem
C:\Program Files\mosquitto>openssl req -x509 -nodes -new -key key.pem -out ca.crt
You are about to be asked to enter information that will be incorporated
into your certificate request.
What you are about to enter is what is called a Distinguished Name or a DN.
There are quite a few fields but you can leave some blank
For some fields there will be a default value,
If you enter '.', the field will be left blank.
-----
Country Name (2 letter code) [AU]:TW
State or Province Name (full name) [Some-State]:Taiwan
Locality Name (eg, city) []:Taipei
Organization Name (eg, company) [Internet Widgits Pty Ltd]:Moxa Inc.
Organizational Unit Name (eg, section) []:
Common Name (e.g. server FQDN or YOUR name) []:192.168.127.200
Email Address []:alexty.chen@moxa.com
C:\Program Files\mosquitto>openssl req -new -key key.pem -out certificate.csr
You are about to be asked to enter information that will be incorporated
into your certificate request.
What you are about to enter is what is called a Distinguished Name or a DN.
There are quite a few fields but you can leave some blank
For some fields there will be a default value,
If you enter '.', the field will be left blank.
-----
Country Name (2 letter code) [AU]:TW
State or Province Name (full name) [Some-State]:Taiwan
Locality Name (eg, city) []:Taipei
```

The files shown below will be generated. Put the files in the mosquitto folder.

Name	Date modified	Type	Size
ca.srl	11/27/2019 2:03 PM	SRL File	1 KB
certificate.crt	11/27/2019 2:03 PM	Security Certificate	1 KB
certificate.csr	11/27/2019 2:03 PM	CSR File	1 KB
ca.crt	11/27/2019 2:02 PM	Security Certificate	1 KB
key.pem	11/27/2019 2:02 PM	PEM File	1 KB

Modify mosquitto.conf

1. Open mosquitto.conf in the mosquitto folder.
2. Type in below certificate information in the #Certificate based SSL/TLS support section.
 - C:\Program Files\mosquitto\ca.crt
 - Certfile C:\Program Files\mosquitto\certificate.crt
 - Keyfile C:\Program Files\mosquitto\key.pem

```
249 # -----
250 # Certificate based SSL/TLS support
251 # -----
252 # The following options can be used to enable SSL/TLS support for
253 # this listener. Note that the recommended port for MQTT over TLS
254 # is 8883, but this must be set manually.
255 #
256 # See also the mosquitto-tls man page.
257
258 # At least one of cafile or capath must be defined. They both
259 # define methods of accessing the PEM encoded Certificate
260 # Authority certificates that have signed your server certificate
261 # and that you wish to trust.
262 # cafile defines the path to a file containing the CA certificates.
263 # capath defines a directory that will be searched for files
264 # containing the CA certificates. For capath to work correctly, the
265 # certificate files must have ".crt" as the file ending and you must run
266 # "openssl rehash <path to capath>" each time you add/remove a certificate.
267 cafile C:\Program Files\mosquitto\ca.crt
268 #capath
269
270 # Path to the PEM encoded server certificate.
271 certfile C:\Program Files\mosquitto\certificate.crt
272 # Path to the PEM encoded keyfile.
273 keyfile C:\Program Files\mosquitto\key.pem
274
```

3. Add broker port 8883 to the end.

```
987 port 8883 # setting TLS port
988
```

4. Enter "mosquitto.exe -v -c mosquitto.conf" in the cmd to start broker

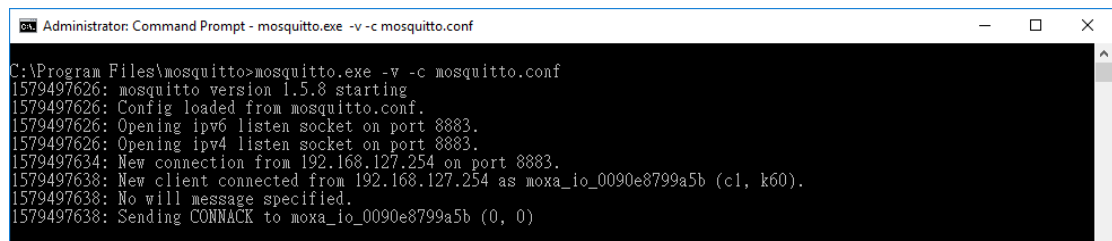

```
Administrator: Command Prompt - mosquitto.exe -v -c mosquitto.conf
C:\Program Files\mosquitto>mosquitto.exe -v -c mosquitto.conf
1579497626: mosquitto version 1.5.8 starting
1579497626: Config loaded from mosquitto.conf.
1579497626: Opening ipv6 listen socket on port 8883.
1579497626: Opening ipv4 listen socket on port 8883.
1579497634: New connection from 192.168.127.254 on port 8883.
1579497638: New client connected from 192.168.127.254 as moxa_io_0090e8799a5b (c1, k60).
1579497638: No will message specified.
1579497638: Sending CONNACK to moxa_io_0090e8799a5b (0, 0)
```

Client (publisher) Setting

Use ioThinX 4510 to publish a message to the broker.

1. Set the Broker IP (your computer's IP) under Connection Settings. Enable TLS, the default Broker Port is 8883.

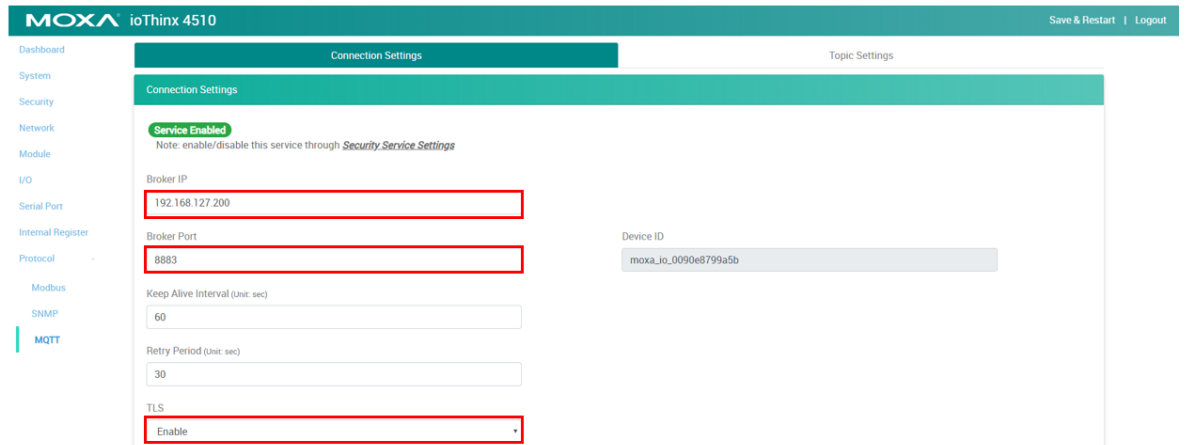

2. Click Publisher and enable Topic#1 (DI-00), then click Save and Restart.

#	Enable	Slot	Channel	Topic	QoS	Retained	Trigger	Condition
1	<input checked="" type="checkbox"/>	R-01	DI-00	Tutorial/read/PUB_Demo@Button/diStatus	0	<input type="checkbox"/>	On Change	(Unit %)

Client (subscriber) setting

Use **mosquitto_sub** to subscribe the topic. **mosquitto_sub** is a simple MQTT version 5/3.1.1 client that will subscribe to topics and print the messages that it receives.

Name	Date modified	Type	Size
putreadvcc.dll	4/10/2019 3:21 AM	Application extension	22 KB
Uninstall.exe	4/8/2019 4:05 PM	Application	65 KB
mosquitto.exe	3/1/2019 3:58 AM	Application	253 KB
mosquitto_pub.exe	3/1/2019 3:57 AM	Application	39 KB
mosquitto_sub.exe	3/1/2019 3:57 AM	Application	41 KB

1. Enter "mosquitto_sub.exe -h 192.168.127.200 -p 8883 -t "#" --cafile certificate.crt" in the cmd to get the message from the broker
2. When trigger the DI-00 channel, the client(subscriber) will get the message.

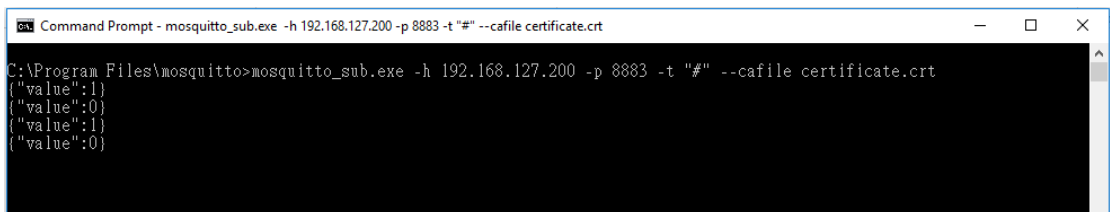

Network Port Usage

Service Type	TCP/UDP	Port	Default
DHCP	UDP	68	Disabled
Web Server	TCP	80	Enabled
RESTful API	TCP	80	Disabled
SNMP Agent	UDP	161	Disabled
HTTPs	TCP	443	Disabled
Modbus/TCP Slave	TCP	502	Enabled
Auto Search	UDP	4800	Enabled
IOxpress/CLI	TCP	10124	Enabled

Modbus/TCP Slave Rules

Supported Function Code

Point Type	Register (decimal)	Access	Type	Supported Function Code
01: COIL STATUS	0xxxx	R/W	bit	1, 5, 15
02: INPUT STATUS	1xxxx	R	bit	2
03: HOLDING REGISTER	4xxxx	R/W	word	3, 6, 16
04: INPUT REGISTER	3xxxx	R	word	4

Exception Code

Code	Name	Comments
1	ILLEGAL FUNCTION	Function code is not valid.
2	ILLEGAL DATA ADDRESS	Data address is not valid.
3	ILLEGAL DATA VALUE	Writing value is not accepted.
4	SLAVE DEVICE FAILURE	Unrecoverable error occurred.

System Registers

01: COIL STATUS

Parameter	Description	Length	Type
boolInternalRegister	BOOL Internal Register (BIR)	48	BOOL

02: INPUT STATUS

Parameter	Description	Length	Type
watchdogAlarmFlag	Watchdog alarm flag status (0: Normal, 1: alarm)	1	BOOL

03: HOLDING REGISTER

Parameter	Description	Length	Type
wirValue	WORD IR - Value	48	WORD
dirValue	DWORD IR - Value	96	DWORD
firValue	FLOAT IR - Value	96	REAL

04: INPUT REGISTER

Parameter	Description	Length	Type
deviceName	device name	8	BYTE
deviceDate	device date e.g. 2016/06/28 -> 20160628	2	DWORD
deviceTime	device local time e.g. 15:48:25 -> 154825	2	DWORD
deviceUpTime	unit: sec(s)	2	DWORD
firmwareVersion	Each byte represents ASCII code. e.g. 1.2.3 --> V1.2.3 , 11.13.12 -->V11.13.12	4	BYTE
firmwareBuildDate	Each byte represents ASCII code. E.g. 16051718 --> Build16051718	4	BYTE
serialNumber	Each byte represents ASCII code of serial number English character : e.g. TAGCB1100001	6	BYTE
lanMac	MAC address	4	BYTE
lanIp	IP address	2	BYTE
systemError	System Error	1	WORD

45MR-1600 (-T), 16 DIs Registers

01: COIL STATUS

Parameter	Description	Length	Type
diCounterStatus	DI - Counter mode - status (0: Pause, 1: Run)	4	BOOL
diCounterOverflowFlagClear	DI - Counter mode - clear overflow flag (1: Clear)	4	BOOL

02: INPUT STATUS

Parameter	Description	Length	Type
diStatus	DI - DI mode - status (0: OFF, 1: ON)	16	BOOL
diMode	DI - mode (0: DI, 1: Counter)	16	BOOL
diCounterOverflowFlag	DI - Counter mode - overflow flag (0: Normal, 1: Overflow)	4	BOOL

03: HOLDING REGISTER

Parameter	Description	Length	Type
diCounterValue	DI - Counter mode - value	8	DWORD
diCounterStatusAll	DI - Counter mode - status (0: Pause, 1: Run)	1	WORD
diCounterOverflowFlagClearAll	DI - Counter mode - clear overflow flag (1: Clear)	1	WORD

04: INPUT REGISTER

Parameter	Description	Length	Type
diStatusAll	DI - DI mode - status (0: OFF, 1: ON)	1	WORD
diCounterOverflowFlagAll	DI - Counter mode - overflow flag (0: Normal, 1: Overflow)	1	WORD
diModeAll	DI - mode (0: DI, 1: Counter)	1	WORD

45MR-1601 (-T), 16 DIs Registers

01: COIL STATUS

Parameter	Description	Length	Type
diCounterStatus	DI - Counter mode - status (0: Pause, 1: Run)	4	BOOL
diCounterOverflowFlagClear	DI - Counter mode - clear overflow flag (1: Clear)	4	BOOL

02: INPUT STATUS

Parameter	Description	Length	Type
diStatus	DI - DI mode - status (0: OFF, 1: ON)	16	BOOL
diMode	DI - mode (0: DI, 1: Counter)	16	BOOL
diCounterOverflowFlag	DI - Counter mode - overflow flag (0: Normal, 1: Overflow)	4	BOOL

03: HOLDING REGISTER

Parameter	Description	Length	Type
diCounterValue	DI - Counter mode - value	8	DWORD
diCounterStatusAll	DI - Counter mode - status (0: Pause, 1: Run)	1	WORD
diCounterOverflowFlagClearAll	DI - Counter mode - clear overflow flag (1: Clear)	1	WORD

04: INPUT REGISTER

Parameter	Description	Length	Type
diStatusAll	DI - DI mode - status (0: OFF, 1: ON)	1	WORD
diCounterOverflowFlagAll	DI - Counter mode - overflow flag (0: Normal, 1: Overflow)	1	WORD
diModeAll	DI - mode (0: DI, 1: Counter)	1	WORD

45MR-2404 (-T), 4 Relays Registers

01: COIL STATUS

Parameter	Description	Length	Type
relayStatus	Relay - Relay mode - status (0: OFF, 1: ON)	4	BOOL
relayCurrentCountReset	Relay - reset current count (1: Reset)	4	BOOL

03: HOLDING REGISTER

Parameter	Description	Length	Type
relayStatusAll	Relay - Relay mode - status (0: OFF, 1: ON)	1	WORD

04: INPUT REGISTER

Parameter	Description	Length	Type
relayTotalCount	Relay - total count	8	DWORD
relayCurrentCount	Relay - current count	8	DWORD

45MR-2600 (-T), 16 DOs Registers

01: COIL STATUS

Parameter	Description	Length	Type
doStatus	DO - status (0: OFF, 1: ON)	16	BOOL
doPulseStatus	DO - Pulse mode - status (0: Stop, 1: Start)	4	BOOL

02: INPUT STATUS

Parameter	Description	Length	Type
doMode	DO - mode (0: DO, 1: Pulse)	16	BOOL

03: HOLDING REGISTER

Parameter	Description	Length	Type
doStatusAll	DO - status (0: OFF, 1: ON)	1	WORD
doPulseCount	DO - Pulse mode - count	8	DWORD
doPulseOnWidth	DO - Pulse mode - ON width (unit: 500 us)	4	WORD
doPulseOffWidth	DO - Pulse mode - OFF width (unit: 500 us)	4	WORD
doPulseStatusAll	DO - Pulse mode - status (0: Stop, 1: Start)	1	WORD

04: INPUT REGISTER

Parameter	Description	Length	Type
doModeAll	DO - mode (0: DO, 1: Pulse)	1	WORD

45MR-2601 (-T), 16 DOs Registers

01: COIL STATUS

Parameter	Description	Length	Type
doStatus	DO - status (0: OFF, 1: ON)	16	BOOL
doPulseStatus	DO - Pulse mode - status (0: Stop, 1: Start)	4	BOOL

02: INPUT STATUS

Parameter	Description	Length	Type
doMode	DO - mode (0: DO, 1: Pulse)	16	BOOL

03: HOLDING REGISTER

Parameter	Description	Length	Type
doStatusAll	DO - status (0: OFF, 1: ON)	1	WORD
doPulseCount	DO - Pulse mode - count	8	DWORD
doPulseOnWidth	DO - Pulse mode - ON width (unit: 500 us)	4	WORD
doPulseOffWidth	DO - Pulse mode - OFF width (unit: 500 us)	4	WORD
doPulseStatusAll	DO - Pulse mode - status (0: Stop, 1: Start)	1	WORD

04: INPUT REGISTER

Parameter	Description	Length	Type
doModeAll	DO - mode (0: DO, 1: Pulse)	1	WORD

45MR-2606 (-T), 8 DIs, 8 DOs Registers

01: COIL STATUS

Parameter	Description	Length	Type
doStatus	DO - status (0: OFF, 1: ON)	8	BOOL
diCounterStatus	DI - Counter mode - status (0: Pause, 1: Run)	2	BOOL
diCounterOverflowFlagClear	DI - Counter mode - clear overflow flag (1: Clear)	2	BOOL
doPulseStatus	DO - Pulse mode - status (0: Stop, 1: Start)	2	BOOL

02: INPUT STATUS

Parameter	Description	Length	Type
diStatus	DI - DI mode - status (0: OFF, 1: ON)	8	BOOL
diMode	DI - mode (0: DI, 1: Counter)	8	BOOL
doMode	DO - mode (0: DO, 1: Pulse)	8	BOOL
diCounterOverflowFlag	DI - Counter mode - overflow flag (0: Normal, 1: Overflow)	2	BOOL

03: HOLDING REGISTER

Parameter	Description	Length	Type
diCounterValue	DI - Counter mode - value	4	DWORD
doStatusAll	DO - status (0: OFF, 1: ON)	1	WORD
doPulseCount	DO - Pulse mode - count	4	DWORD
doPulseOnWidth	DO - Pulse mode - ON width (unit: 500 us)	2	WORD
doPulseOffWidth	DO - Pulse mode - OFF width (unit: 500 us)	2	WORD
doPulseStatusAll	DO - Pulse mode - status (0: Stop, 1: Start)	1	WORD
diCounterStatusAll	DI - Counter mode - status (0: Pause, 1: Run)	1	WORD
diCounterOverflowFlagClearAll	DI - Counter mode - clear overflow flag (1: Clear)	1	WORD

04: INPUT REGISTER

Parameter	Description	Length	Type
diStatusAll	DI - DI mode - status (0: OFF, 1: ON)	1	WORD
diCounterOverflowFlagAll	DI - Counter mode - overflow flag (0: Normal, 1: Overflow)	1	WORD
diModeAll	DI - mode (0: DI, 1: Counter)	1	WORD
doModeAll	DO - mode (0: DO, 1: Pulse)	1	WORD

45MR-3800 (-T), 8 AIs Registers

01: COIL STATUS

Parameter	Description	Length	Type
aiResetMinValue	AI - reset minimum value (1: Reset)	8	BOOL
aiResetMaxValue	AI - reset maximum value (1: Reset)	8	BOOL

03: HOLDING REGISTER

Parameter	Description	Length	Type
aiResetMinValueAll	AI - reset minimum value (1: Reset)	1	WORD
aiResetMaxValueAll	AI - reset maximum value (1: Reset)	1	WORD

04: INPUT REGISTER

Parameter	Description	Length	Type
aiValueRaw	AI - raw value	8	WORD
aiValueRawMin	AI - minimum raw value	8	WORD
aiValueRawMax	AI - maximum raw value	8	WORD
aiValueScaled	AI - scaled value	16	REAL
aiValueScaledMin	AI - minimum scaled value	16	REAL
aiValueScaledMax	AI - maximum scaled value	16	REAL
aiStatus	AI - status (0: normal, 1: burnout, 2: over range, 3. under range)	8	WORD
aiBurnoutValueScaled	AI - scaled burnout value	16	REAL
aiMode	AI - mode (0: disable, 1: 0-10 V, 2: 0-20 mA, 3: 4-20 mA burnout, 4: 4-20 mA, 5: ±10 V)	8	WORD

45MR-3810 (-T), 8 AIs Registers

01: COIL STATUS

Parameter	Description	Length	Type
aiResetMinValue	AI - reset minimum value (1: Reset)	8	BOOL
aiResetMaxValue	AI - reset maximum value (1: Reset)	8	BOOL

03: HOLDING REGISTER

Parameter	Description	Length	Type
aiResetMinValueAll	AI - reset minimum value (1: Reset)	1	WORD
aiResetMaxValueAll	AI - reset maximum value (1: Reset)	1	WORD

04: INPUT REGISTER

Parameter	Description	Length	Type
aiValueRaw	AI - raw value	8	WORD
aiValueRawMin	AI - minimum raw value	8	WORD
aiValueRawMax	AI - maximum raw value	8	WORD
aiValueScaled	AI - scaled value	16	REAL
aiValueScaledMin	AI - minimum scaled value	16	REAL
aiValueScaledMax	AI - maximum scaled value	16	REAL
aiStatus	AI - status (0: normal, 1: burnout, 2: over range, 3. under range)	8	WORD
aiBurnoutValueScaled	AI - scaled burnout value	16	REAL
aiMode	AI - mode (0: disable, 1: 0-10 V, 2: 0-20 mA, 3: 4-20 mA burnout, 4: 4-20 mA, 5: ±10 V)	8	WORD

45MR-4420 (-T), 4 AOs Registers

03: HOLDING REGISTER

Parameter	Description	Length	Type
aoValueRaw	AO - raw value	4	WORD
aoValueScaled	AO - scaled value	8	REAL

04: INPUT REGISTER

Parameter	Description	Length	Type
aoMode	AO - mode (0: disable, 1: 0-10 V, 2: 0-20 mA, 3: 4-20 mA, 4: ± 10 V)	4	WORD

45MR-6600 (-T), 6 RTDs Registers

01: COIL STATUS

Parameter	Description	Length	Type
rtdResetMinValue	RTD - reset minimum value (1: Reset)	6	BOOL
rtdResetMaxValue	RTD - reset maximum value (1: Reset)	6	BOOL

03: HOLDING REGISTER

Parameter	Description	Length	Type
rtdResetMinValueAll	RTD - reset minimum value (1: Reset)	1	WORD
rtdResetMaxValueAll	RTD - reset maximum value (1: Reset)	1	WORD

04: INPUT REGISTER

Parameter	Description	Length	Type
rtdValueScaled	RTD - scaled value	12	REAL
rtdValueScaledMin	RTD - minimum scaled value	12	REAL
rtdValueScaledMax	RTD - maximum scaled value	12	REAL
rtdType	RTD - Type (0: PT50, 1: PT100, 2: PT200, 3: PT500, 4: PT1000; 14: 310 Ohm, 15: 620 Ohm, 16: 1250 Ohm, 17: 2200 Ohm; 20: JPT100, 21: JPT200, 22: JPT500, 23: JPT1000; 30: NI100, 31: NI200, 32: NI500, 33: NI1000, 34: NI120)	6	WORD
rtdStatus	RTD - Status (0: normal, 1: burnout)	6	WORD

45MR-6810 (-T), 8 TCs Registers

01: COIL STATUS

Parameter	Description	Length	Type
tcResetMinValue	TC - reset minimum value (1: Reset)	8	BOOL
tcResetMaxValue	TC - reset maximum value (1: Reset)	8	BOOL

03: HOLDING REGISTER

Parameter	Description	Length	Type
tcResetMinValueAll	TC - reset minimum value (1: Reset)	1	WORD
tcResetMaxValueAll	TC - reset maximum value (1: Reset)	1	WORD

04: INPUT REGISTER

Parameter	Description	Length	Type
tcValueScaled	TC - scaled value	16	REAL
tcValueScaledMin	TC - minimum scaled value	16	REAL
tcValueScaledMax	TC - maximum scaled value	16	REAL
tcType	TC - Type (0: J Type, 1: K Type, 2: T Type, 3: E Type, 4: R Type, 5: S Type, 6: B Type, 7: N Type, 14: ± 78.126 mV, 15: ± 39.062 mV, 16: ± 19.532 mV)	8	WORD
tcStatus	TC - Status (0: normal, 1: burnout)	8	WORD

45MR-7210(-T), System and Field Power Input Registers

Parameters	Description	Length	Type
spStatus	SP - system power Status	1	WORD
spLowerLimitValue	SP - system power lower limit value	2	REAL
fpStatus	FP - Field Power Status	1	WORD

SNMP Rules

All OIDs of this device begin with .1.3.6.1.4.1.8691.10.4510. The data can be read or written by a network management software with the following OIDs. Download the latest version of the MIB file from www.moxa.com for additional information.

OID	Type
.1.3.6.1.4.1.8691.10.4510.1	systemInfo
.1.3.6.1.4.1.8691.10.4510.2	systemPower
.1.3.6.1.4.1.8691.10.4510.3	fieldPower
.1.3.6.1.4.1.8691.10.4510.11	di
.1.3.6.1.4.1.8691.10.4510.12	do
.1.3.6.1.4.1.8691.10.4510.13	relay
.1.3.6.1.4.1.8691.10.4510.21	ai
.1.3.6.1.4.1.8691.10.4510.22	ao
.1.3.6.1.4.1.8691.10.4510.23	rtd
.1.3.6.1.4.1.8691.10.4510.24	tc
.1.3.6.1.4.1.8691.10.4510.41	internalRegister
.1.3.6.1.4.1.8691.10.4510.91	event
.1.3.6.1.4.1.8691.10.4510.92	eventTriggerType
.1.3.6.1.4.1.8691.10.4510.93	systemEvent

RESTful API Rules

Supported Request Method

Request	Description
GET	The GET method is used to retrieve information from the given server using a given URI. Requests using GET should only retrieve data and should have no other effect on the data.
PUT	Replaces all the current representations of the target resource with the uploaded content.
OPTIONS	Describe the communication options for the target resource.

GET Request Components

Component	Content	Description
Request Method	GET	Use GET request to retrieve information
URL	http://{IP address}/{RESTful API}	Refer to RESTful API List
Headers	Accept: vdn.dac.v2 Content-Type: application/json	Headers are mandatory for all RESTful API requests

PUT Request Components

Component	Content	Description
Request Method	PUT	Use PUT request to replace current representation
URL	http://{IP address}/{RESTful API}	Refer to RESTful API List
Headers	Accept: vdn.dac.v2 Content-Type: application/json	Headers are mandatory for all RESTful API requests

Component	Content	Description
Body	{"value":1}	Uploaded content for replacing current representation

RESTful API List

Here lists the RESTful APIs supported by this device. The {ioName} is composed with three elements, including **Module_Name**, @, and **I/O_Channel_Name**. For example, the {ioName} of the module name "45MR-1600-0" and the DI channel name "DI-00" is 45MR-1600-0@DI-00.

RESTful API	Description	Access	Format
/api/sysInfo	All system information	R	
/api/sysInfo/device	Device name	R	
	Device local date and time	R	yyyy/mm/dd hh:mm:ss
	Device up time	R	hh:mm:ss
	Firmware version	R	
	Serial number	R	
	System error	R	
	Module name and serial number	R	["Module name", "Module serial number"]
/api/sysInfo/network	All network information	R	
/api/sysInfo/network/LAN	All LAN information	R	
/api/sysInfo/network/LAN/1	MAC address	R	xx:xx:xx:xx:xx:xx
	IP address	R	xxx.xxx.xxx.xxx
/api/io/ir/{ioName}	IR - value	R	By data type
/api/io/ir/{ioName}/irvalue	IR - value	RW	By data type
/api/io/sp/{ioName}/spStatus	SP - system power status for 45MR-7210(-T)	R	0, 1, 2
/api/io/sp/{ioName}/spLowerLimitValue	SP - system power lower limit value - for 45MR-7210(-T)	R	Float
/api/io/fp/{ioName}/fpStatus	FP - field power status - for 45MR-7210(-T)	R	
/api/io/di/{ioName}/diMode	DI - mode (0: DI, 1: Counter)	R	0 or 1
/api/io/di/{ioName}/diStatus	DI - DI mode - status (0: OFF, 1: ON)	R	0 or 1
/api/io/di/{ioName}/diCounterValue	DI - Counter mode - value	R/W	0 to 4294967295
/api/io/di/{ioName}/diCounterOverflowFlag	DI - Counter mode - overflow flag (0: Normal, 1: Overflow)	R	0 or 1
/api/io/di/{ioName}/diCounterOverflowFlagClear	DI - Counter mode - clear overflow flag (1: Clear)	R/W	0 or 1
/api/io/di/{ioName}/diCounterStatus	DI - Counter mode - status (0: pause, 1: run)	R/W	0 or 1
/api/io/do/{ioName}/doMode	DO - mode (0: DO, 1: Pulse)	R	0 or 1
/api/io/do/{ioName}/doStatus	DO - status (0: OFF, 1: ON)	R/W	0 or 1
/api/io/do/{ioName}/doPulseCount	DO - Pulse mode - count	R/W	0 to 65535
/api/io/do/{ioName}/doPulseOnWidth	DO - Pulse mode - ON width (unit: 500us)	R/W	1 to 65535
/api/io/do/{ioName}/doPulseOffWidth	DO - Pulse mode - OFF width (unit: 500us)	R/W	1 to 65535
/api/io/do/{ioName}/doPulseStatus	DO - Pulse mode - status (0: Stop 1: Start)	R/W	0 or 1
/api/io/relay/{ioName}/relayTotalCount	Relay - total count	R	0 to 4294967295
/api/io/relay/{ioName}/relayCurrentCount	Relay - current count	R	0 to 4294967295

RESTful API	Description	Access	Format
/api/io/relay/{ioName}/relayCurrentCountReset	Relay - reset current count (1: Reset)	R/W	0 or 1
/api/io/relay/{ioName}/relayStatus	Relay - Relay mode - status (0: OFF, 1: ON)	R/W	0 or 1
/api/io/ai/{ioName}/aiMode	AI - mode (0: disable 1: 0-10 V, 2: 0-20 mA, 3: 4-20 mA burnout, 4: 4-20 mA, 5: ±10 V)	R	0, 1, 2, 3, 4, 5
/api/io/ai/{ioName}/aiValueRaw	AI - raw value	R	0 to 65535
/api/io/ai/{ioName}/aiValueRawMin	AI - minimum raw value	R	0 to 65535
/api/io/ai/{ioName}/aiValueRawMax	AI - maximum raw value	R	0 to 65535
/api/io/ai/{ioName}/aiResetMinValue	AI - reset minimum value (1: Reset)	R/W	1
/api/io/ai/{ioName}/aiResetMaxValue	AI - reset maximum value (1: Reset)	R/W	1
/api/io/ai/{ioName}/aiStatus	AI - status (0: normal, 1: burnout, 2: over range, 3: under range)	R	0, 1, 2, 3
/api/io/ai/{ioName}/aiBurnoutValueScaled	AI - scaled burnout value	R	Float
/api/io/ai/{ioName}/aiValueScaled	AI - scaled value	R	Float
/api/io/ai/{ioName}/aiValueScaledMin	AI - minimum scaled value	R	Float
/api/io/ai/{ioName}/aiValueScaledMax	AI - maximum scaled value	R	Float
/api/io/ao/{ioName}/aoMode	AO - mode (0: disable, 1: 0-10 V, 2: 0-20mA, 3: 4-20 mA, 4: +/-10V)	R	0, 1, 2, 3, 4
/api/io/ao/{ioName}/aoValueRaw	AO - raw value	R/W	0 to 65535
/api/io/ao/{ioName}/aoValueScaled	AO - scaled value	R/W	0 to 4294967295
/api/io/rtd/{ioName}/rtdStatus	RTD - Status (0: normal, 1: burnout)	R	0 or 1
/api/io/rtd/{ioName}/rtdMode	RTD - Type (0: PT50, 1: PT100, 2: PT200, 3: PT500, 4: PT1000; 14: 310 Ohm, 15: 620 Ohm, 16: 1250 Ohm, 17: 2200 Ohm; 20: JPT100, 21: JPT200, 22: JPT500, 23: JPT1000; 30: NI100, 31: NI200, 32: NI500, 33: NI1000, 34: NI120)	R	
/api/io/rtd/{ioName}/rtdValueScaled	RTD - scaled value	R	Float
/api/io/rtd/{ioName}/rtdValueScaledMin	RTD - minimum scaled value	R	Float
/api/io/rtd/{ioName}/rtdValueScaledMax	RTD - maximum scaled value	R	Float
/api/io/rtd/{ioName}/rtdResetMinValue	RTD - reset minimum value (1: RESET)	R/W	1
/api/io/rtd/{ioName}/rtdResetMaxValue	RTD - reset maximum value (1: RESET)	R/W	1
/api/io/tc/{ioName}/tcStatus	TC - Status (0: normal, 1: burnout)	R	0 or 1
/api/io/tc/{ioName}/tcType	TC - Type (0: J Type, 1: K Type, 2: T Type, 3: E Type, 4: R Type, 5: S Type, 6: B Type, 7: N Type, 14: ±78.126 mV, 15: ±39.062 mV, 16: ±19.532 mV)	R	
/api/io/tc/{ioName}/tcValueScaled	TC - scaled value	R	Float
/api/io/tc/{ioName}/tcValueScaledMin	TC - minimum scaled value	R	Float
/api/io/tc/{ioName}/tcValueScaledMax	TC - maximum scaled value	R	Float

RESTful API	Description	Access	Format
/api/io/tc/{ioName}/tcResetMinValue	TC - reset minimum value (1: RESET)	R/W	1
/api/io/tc/{ioName}/tcResetMaxValue	TC - reset maximum value (1: RESET)	R/W	1

Exception Code

HTTP Status Code		Moxa Status Code/Description		User message
400	Bad Request	101	UnsupportedVersion	The content version specified in the request is not supported.
400	Bad Request	102	UnsupportedDocFormat	The document format specified in the request is not supported.
400	Bad Request	201	InvalidJsonFormat	The json format in the request is not valid.
400	Bad Request	202	InvalidNodeValue	One of the node value is invalid.
400	Bad Request	203	WrongChannelOrder	The I/O channels are disordered.
400	Bad Request	204	MissingRequiredChannel	A required channel index was not specified in the request body.
400	Bad Request	206	MissingRequiredNode	A required node was not specified in the request body.
400	Bad Request	300	ContentFailed	One of the channel contents in the request could not be set. Please refer to the detailed information.
400	Bad Request	301	ContentFailedToSet	The content in the request could not be set (invalid value).
200	OK	N/A		
404	Bad Request	N/A		
405	Method Not Allowed	N/A		

MQTT Rules

Publish Topic

Topic	Description	Category	Trigger
{deviceName}/read/device/deviceName	device name	attribute	Interval
{deviceName}/read/device/deviceLocalDateTime	device local date and time	attribute	Interval
{deviceName}/read/device/deviceUpTime	device up time	attribute	Interval
{deviceName}/read/device/firmwareVersion	firmware version	attribute	Interval
{deviceName}/read/device/serialNumber	serial number	attribute	Interval
{deviceName}/read/device/systemError	system error	attribute	Interval
{deviceName}/read/network/lanMac/1	MAC address	attribute	Interval
{deviceName}/read/network/lanIp/1	IP address	attribute	Interval
{deviceName}/read/lastWill	Last Will Topic	attribute	Interval
{deviceName}/read/{ioName}/birValue	BIR - value	attribute	both (OnChange)
{deviceName}/read/{ioName}/wirValue	WIR - value	attribute	Interval
{deviceName}/read/{ioName}/dirValue	DIR - value	attribute	Interval
{deviceName}/read/{ioName}/firValue	FIR - value	attribute	Interval
{deviceName}/read/{ioName}/spStatus	SP—for 45MR-7210(-T)—system power status	attribute	Interval

Topic	Description	Category	Trigger
{deviceName}/read/{ioName}/spLowerLimitValue	SP—for 45MR-7210(-T)—system power lower limit value	attribute	Interval
{deviceName}/read/{ioName}/fpStatus	FP—for 45MR-7210(-T)—field power status	attribute	Interval
{deviceName}/read/{ioName}/diMode	DI - mode (0: DI, 1: Counter)	attribute	Interval
{deviceName}/read/{ioName}/diStatus	DI - DI mode - status (0: OFF, 1: ON)	value	both (OnChange)
{deviceName}/read/{ioName}/diCounterValue	DI - Counter mode - value	value	Interval
{deviceName}/read/{ioName}/diCounterOverflowFlag	DI - Counter mode - overflow flag (0: Normal, 1: Overflow)	attribute	Interval
{deviceName}/read/{ioName}/diCounterOverflowFlagClear	DI - Counter mode - clear overflow flag (1: Clear)	attribute	Interval
{deviceName}/read/{ioName}/diCounterStatus	DI - Counter mode - status (0: pause, 1: run)	value	both (OnChange)
{deviceName}/read/{ioName}/doMode	DO - mode (0: DO, 1: Pulse)	attribute	Interval
{deviceName}/read/{ioName}/doStatus	DO - status (0: OFF, 1: ON)	value	both (OnChange)
{deviceName}/read/{ioName}/doPulseCount	DO - Pulse mode - count	attribute	Interval
{deviceName}/read/{ioName}/doPulseOnWidth	DO - Pulse mode - ON width (unit: 500us)	attribute	Interval
{deviceName}/read/{ioName}/doPulseOffWidth	DO - Pulse mode - OFF width (unit: 500us)	attribute	Interval
{deviceName}/read/{ioName}/doPulseStatus	DO - Pulse mode - status (0: Stop 1: Start)	value	both (OnChange)
{deviceName}/read/{ioName}/relayTotalCount	Relay - total count	attribute	Interval
{deviceName}/read/{ioName}/relayCurrentCount	Relay - current count	value	Interval
{deviceName}/read/{ioName}/relayCurrentCountReset	Relay - reset current count (1: Reset)	attribute	Interval
{deviceName}/read/{ioName}/relayStatus	Relay - Relay mode - status (0: OFF, 1: ON)	value	both (OnChange)
{deviceName}/read/{ioName}/aiMode	AI - mode (0: disable 1: 0-10 V, 2: 0-20 mA, 3: 4-20 mA burnout, 4: 4-20 mA, 5: ±10 V)	attribute	Interval
{deviceName}/read/{ioName}/aiValueRaw	AI - raw value	attribute	Interval
{deviceName}/read/{ioName}/aiValueRawMin	AI - minimum raw value	attribute	Interval
{deviceName}/read/{ioName}/aiValueRawMax	AI - maximum raw value	attribute	Interval
{deviceName}/read/{ioName}/aiResetMinValue	AI - reset minimum value (1: Reset)	attribute	Interval
{deviceName}/read/{ioName}/aiResetMaxValue	AI - reset maximum value (1: Reset)	attribute	Interval
{deviceName}/read/{ioName}/aiStatus	AI - status (0: normal, 1: burnout, 2: over range, 3. under range)	value	both (OnChange)
{deviceName}/read/{ioName}/aiBurnoutValueScaled	AI - scaled burnout value	attribute	Interval
{deviceName}/read/{ioName}/aiValueScaled	AI - scaled value	value	both (interval)

Topic	Description	Category	Trigger
{deviceName}/read/{ioName}/aiValueScaledMin	AI - minimum scaled value	attribute	Interval
{deviceName}/read/{ioName}/aiValueScaledMax	AI - maximum scaled value	attribute	Interval
{deviceName}/read/{ioName}/aoMode	AO - mode (0: Disable, 1: 0-10 V, 2: 0-20mA, 3: 4-20 mA)	attribute	Interval
{deviceName}/read/{ioName}/aoValueRaw	AO - raw value	attribute	Interval
{deviceName}/read/{ioName}/aoValueScaled	AO - scaled value	value	both (interval)
{deviceName}/read/{ioName}/aoStatus	AO - status (0: Normal, 1: Fault)	value	both (OnChange)
{deviceName}/read/{ioName}/rtdStatus	RTD - Status (0: normal, 1: burnout)	value	both (OnChange)
{deviceName}/read/{ioName}/rtdMode	RTD - Type (0: PT50, 1: PT100, 2: PT200, 3: PT500, 4: PT1000; 14: 310 Ohm, 15: 620 Ohm, 16: 1250 Ohm, 17: 2200 Ohm; 20: JPT100, 21: JPT200, 22: JPT500, 23: JPT1000; 30: NI100, 31: NI200, 32: NI500, 33: NI1000, 34: NI120, 50: disable)	attribute	Interval
{deviceName}/read/{ioName}/rtdValueScaled	RTD - scaled value	value	both (interval)
{deviceName}/read/{ioName}/rtdValueScaledMin	RTD - minimum scaled value	attribute	Interval
{deviceName}/read/{ioName}/rtdValueScaledMax	RTD - maximum scaled value	attribute	Interval
{deviceName}/read/{ioName}/rtdResetMinValue	RTD - reset minimum value (1: RESET)	attribute	Interval
{deviceName}/read/{ioName}/rtdResetMaxValue	RTD - reset maximum value (1: RESET)	attribute	Interval
{deviceName}/read/{ioName}/tcStatus	TC - Status (0: normal, 1: burnout)	value	both (OnChange)
{deviceName}/read/{ioName}/tcType	TC - Type (0: J Type, 1: K Type, 2: T Type, 3: E Type, 4: R Type, 5: S Type, 6: B Type, 7: N Type, 14: ±78.126 mV, 15: ±39.062 mV, 16: ±19.532 mV, 50: disable)	attribute	Interval
{deviceName}/read/{ioName}/tcValueScaled	TC - scaled value	value	both (interval)
{deviceName}/read/{ioName}/tcValueScaledMin	TC - minimum scaled value	attribute	Interval
{deviceName}/read/{ioName}/tcValueScaledMax	TC - maximum scaled value	attribute	Interval
{deviceName}/read/{ioName}/tcResetMinValue	TC - reset minimum value (1: RESET)	attribute	Interval
{deviceName}/read/{ioName}/tcResetMaxValue	TC - reset maximum value (1: RESET)	attribute	Interval
{deviceName}/write/{ioName}/tcResetMinValue	TC - reset minimum value (1: RESET)	attribute	Interval
{deviceName}/write/{ioName}/tcResetMaxValue	TC - reset maximum value (1: RESET)	attribute	N/A

Subscribe Topic

Topic	Description	Template	Category
{deviceName}/write/{ioName}/birValue	BIR - value	0 to 1	value
{deviceName}/write/{ioName}/wirValue	WIR - value	-32768 to 32767	value
{deviceName}/write/{ioName}/dirValue	DIR - value	-2147483648 to 2147483647	value
{deviceName}/write/{ioName}/firValue	FIR - value	Float	value
{deviceName}/write/{ioName}/diCounterValue	DI - Counter mode - value	0 to 4294967295	value
{deviceName}/write/{ioName}/diCounterOverflowFlagClear	DI - Counter mode - clear overflow flag (1: Clear)	0 or 1	attribute
{deviceName}/write/{ioName}/diCounterStatus	DI - Counter mode - status (0: pause, 1: run)	0 or 1	value
{deviceName}/write/{ioName}/doStatus	DO - status (0: OFF, 1: ON)	0 or 1	value
{deviceName}/write/{ioName}/doPulseCount	DO - Pulse mode - count	0 to 65535	attribute
{deviceName}/write/{ioName}/doPulseOnWidth	DO - Pulse mode - ON width (unit: 500us)	1 to 65535	attribute
{deviceName}/write/{ioName}/doPulseOffWidth	DO - Pulse mode - OFF width (unit: 500us)	1 to 65535	attribute
{deviceName}/write/{ioName}/doPulseStatus	DO - Pulse mode - status (0: Stop 1: Start)	0 or 1	value
{deviceName}/write/{ioName}/relayCurrentCountReset	Relay - reset current count (1: Reset)	0 or 1	attribute
{deviceName}/write/{ioName}/relayStatus	Relay - Relay mode - status (0: OFF, 1: ON)	0 or 1	value
{deviceName}/write/{ioName}/aiResetMinValue	AI - reset minimum value (1: Reset)	1	attribute
{deviceName}/write/{ioName}/aiResetMaxValue	AI - reset maximum value (1: Reset)	1	attribute
{deviceName}/write/{ioName}/aoValueRaw	AO - raw value	0 to 65535	attribute
{deviceName}/write/{ioName}/aoValueScaled	AO - scaled value	0 to 4294967295	value
{deviceName}/write/{ioName}/rtdResetMinValue	RTD - reset minimum value (1: RESET)	1	attribute
{deviceName}/write/{ioName}/rtdResetMaxValue	RTD - reset maximum value (1: RESET)	1	attribute
{deviceName}/write/{ioName}/tcResetMinValue	TC - reset minimum value (1: RESET)	1	attribute
{deviceName}/write/{ioName}/tcResetMaxValue	TC - reset maximum value (1: RESET)	1	attribute

Troubleshooting

This section provides troubleshooting instructions for this device.

Forgot Username and Password

If you forget your username and password, use a pointed object such as a straightened paper clip to hold down the Reset Button for 10 seconds. This will restart the unit and reset all settings on the device, including the username and password. The factory defaults will be loaded once the READY LED turns green again.



INFORMATION

The default username is admin, and the default password is moxa.

Forgot IP Address of the Unit

If you forget the IP address of the unit, use IOxpress utility to search for the device if IOxpress service is already enabled in **Security > Service Settings**. Otherwise, load the factory default settings and access the unit with the default IP address.

Step 1: Open IOxpress, go to **Device Library** and click **Device > Search** in the menu.

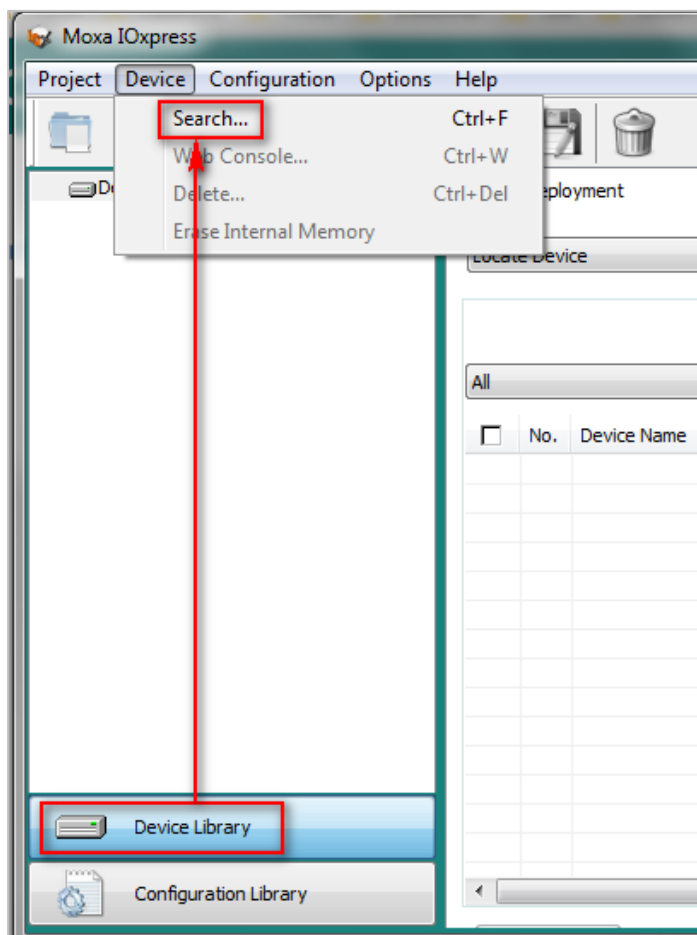

Step 2: In the **Search for Devices** window, choose the product series you would like to search in the **By Product Series** dropdown menu, and then click the **Submit** button. IOxpress will start to search the devices and list them in the table.

The screenshot shows a window titled "Search for Devices" with three tabs: LAN, WAN, and CDA. The LAN tab is active. There are four radio buttons for search criteria: "By Product Series" (selected), "By Product Model", "By MAC Address", and "By IP Address". The "By Product Series" dropdown is set to "All". The "By Product Model" dropdown is also set to "All". The "By MAC Address" field is filled with "00 : 90 : E8 : 00 : 00 : 01". The "By IP Address" field has "192 . 168 . 1 . 1" in the first box, "to" in the middle, and "192 . 168 . 1 . 254" in the second box. A note next to the second IP box says "(leave second IP blank if searching for a single device)". Below the IP fields is a "Mask" field with "255 . 255 . 255 . 0". At the bottom right, there are "Submit" and "Cancel" buttons.

Failed to Update Firmware

If the firmware update process fails, the firmware file may be corrupted. Download the firmware file from Moxa's official website. Otherwise, check if the power supply is stable. An unstable power supply can lead to an incomplete firmware update.



NOTE

This device supports firmware automatic recovery function. If the firmware in the device is corrupted, the system will load the backup firmware automatically to overwrite the corrupted one. When the system is in recovery mode, the RDY LED will blink RED slowly. Do not disconnect the power cable when performing the recovery process. After the recovery process is complete, you can update firmware again.

Failed to Update Configuration

If the configuration update process fails, the configuration file may be corrupted. Get the configuration file and update it again. Otherwise, check to see if the power supply is stable. An unstable power supply can result in the configurations not being successfully updated.

Failed to Access the Unit Through IP Address and IOxpress

Incorrect network configurations can result in the user not being able to access the unit. Check if the device and PC are in the same subnet by following the procedure below.

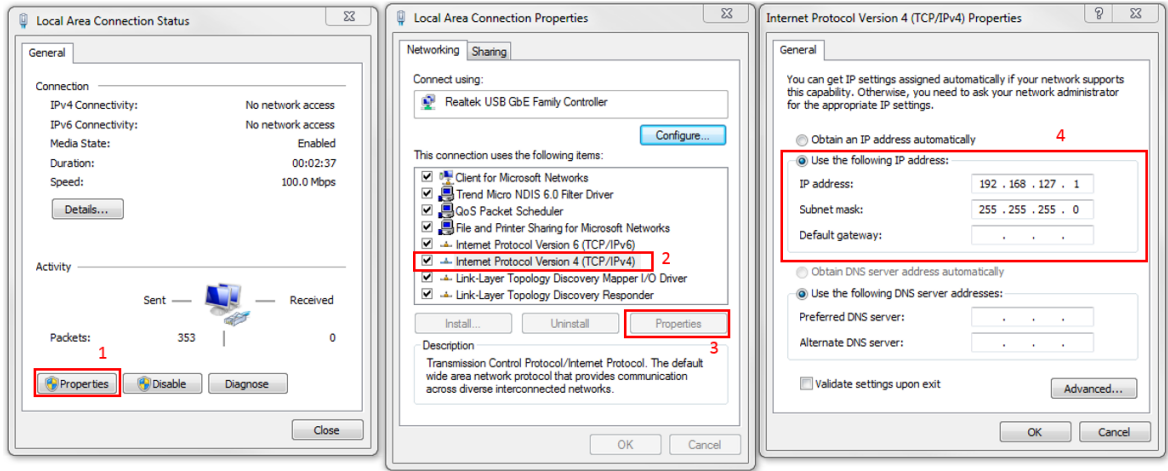

INFORMATION

The default IP address of the device is 192.168.127.254.

This may also occur when you try to configure multiple devices with the same computer. The reason for this could be that multiple devices have the same default IP address. When sending TCP/IP packets, the packet may get sent to the wrong MAC address, as it follows the previous record in the computer's ARP Cache. To rectify this problem, you can erase the ARP Cache records by entering "arp -d" command in the built-in Command-Line tools.



Failed to Enter System Ready Mode

If the RDY LED stays red, and your web console is not accessible, it means that the system is experiencing an error. Follow the steps to recover the system.

- Step 1:** Hold down the RESET button for 30 seconds to trigger the system recovery process. The system will load the backup firmware and then restart the unit. The system is ready when the RDY LED is green.
- Step 2:** Open the web console and then update the firmware and configurations to the device.

Import Self-signed Certificate

When using web service via https, you must import the self-signed certificate before using the web service via https, or the browser may block the connection. Take the following steps to import the self-signed certificate, which was generated by the ioThinX 4510, into the browser.

1. Download the self-signed certificate from the ioThinX 4510.
2. Open **Manage computer certificates** from windows.

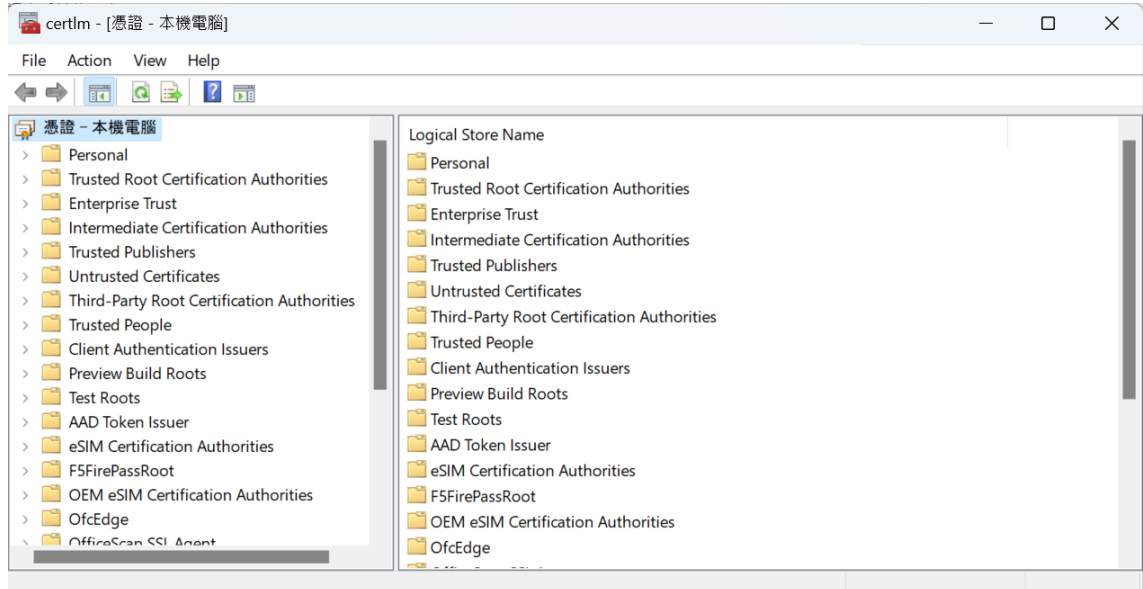

3. Open the Trusted Root Certification Authorities folder, right-click Certificates folder and choose **All Tasks > Import**.

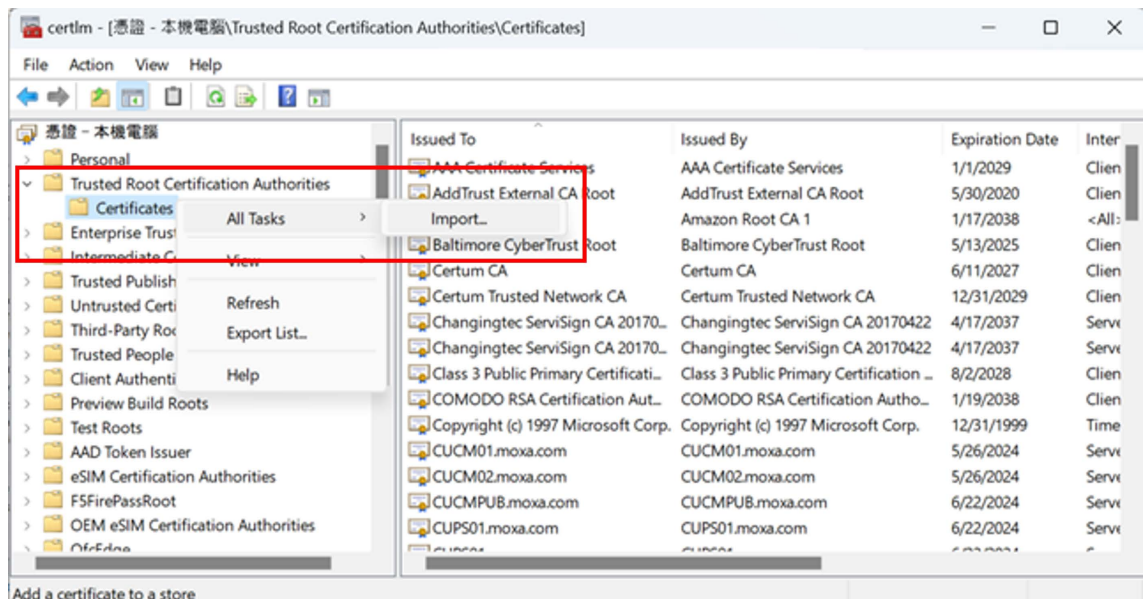

4. Click **Next** and choose **Browser**.

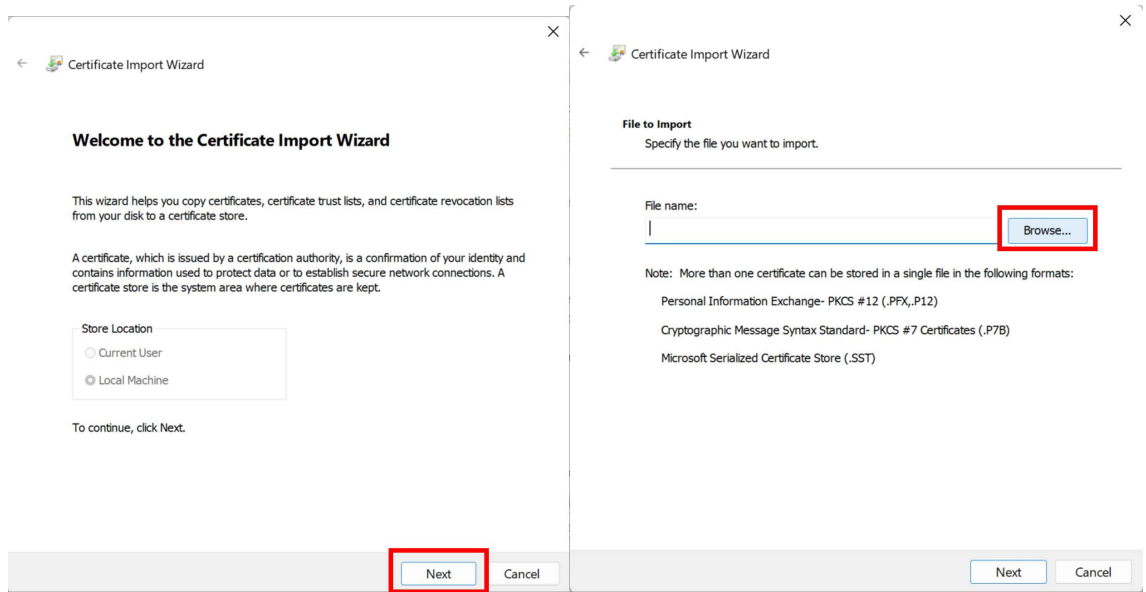

5. Browse and open your Certificate and click **Open**.

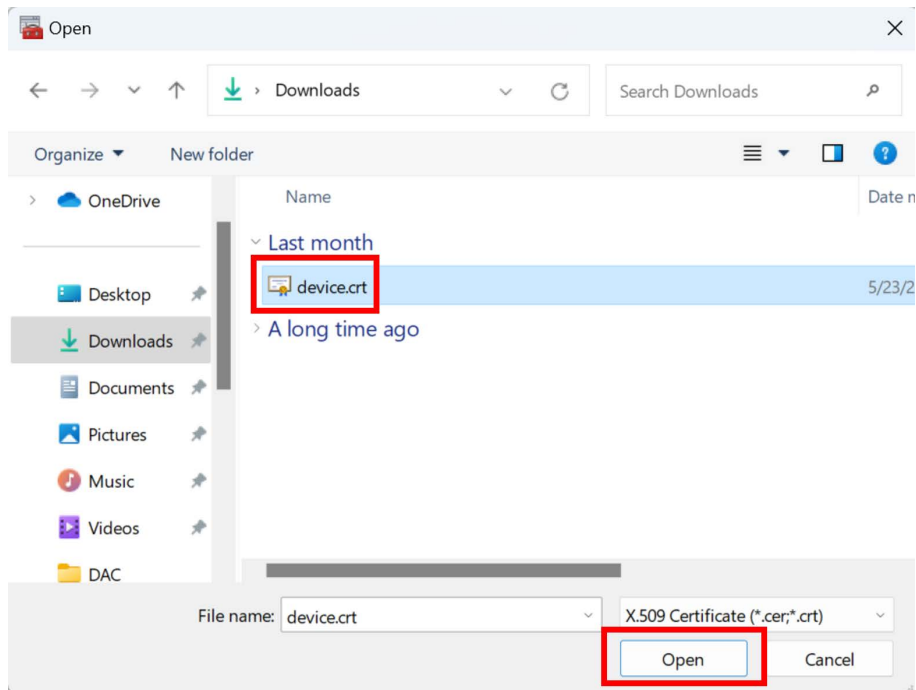

- Place the certificate in the Trusted Root Certification Authorities folder and press **Next**.

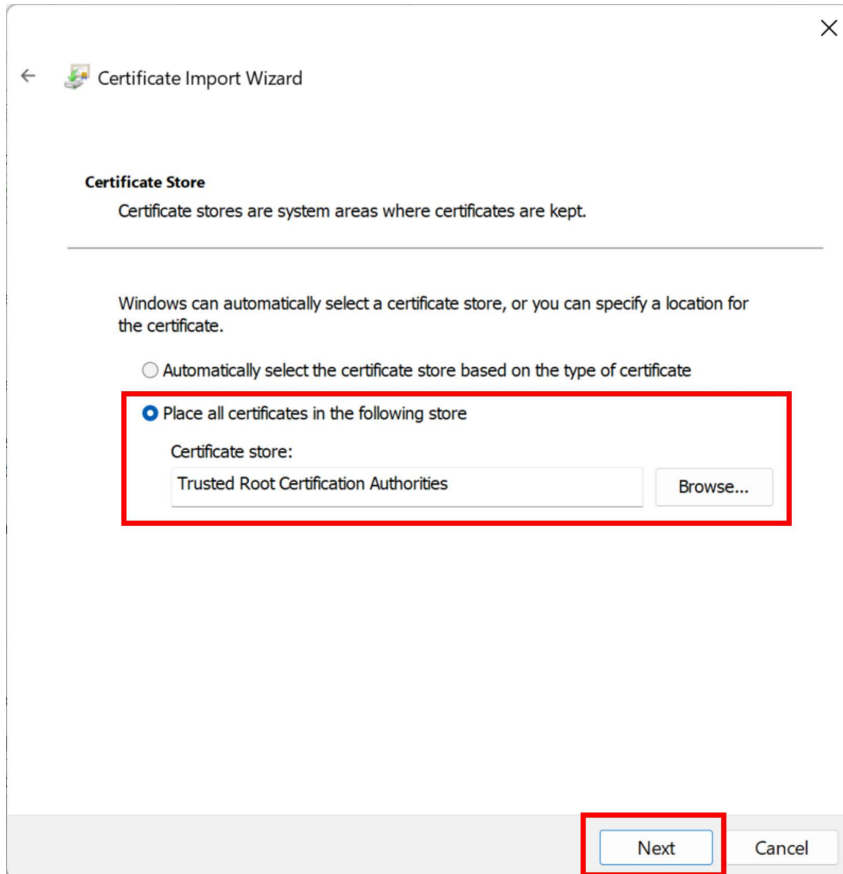

- Check the information and press **Finish**.

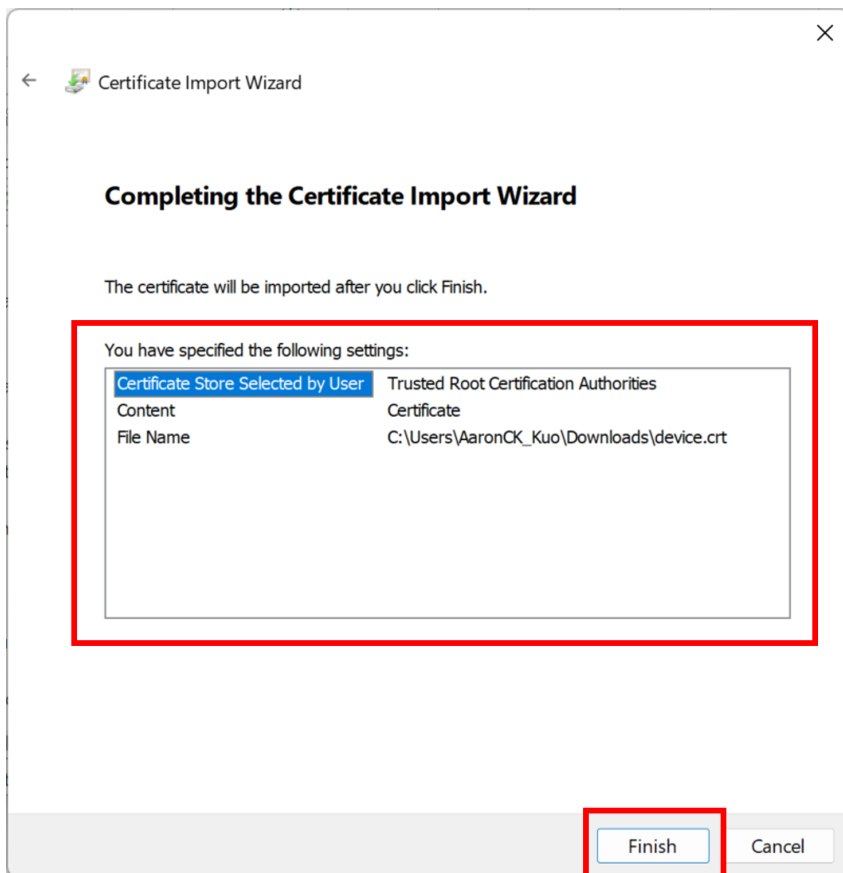

- Open the Firefox browser and check if you can connect to ioThinx 4510 web console via HTTPs.

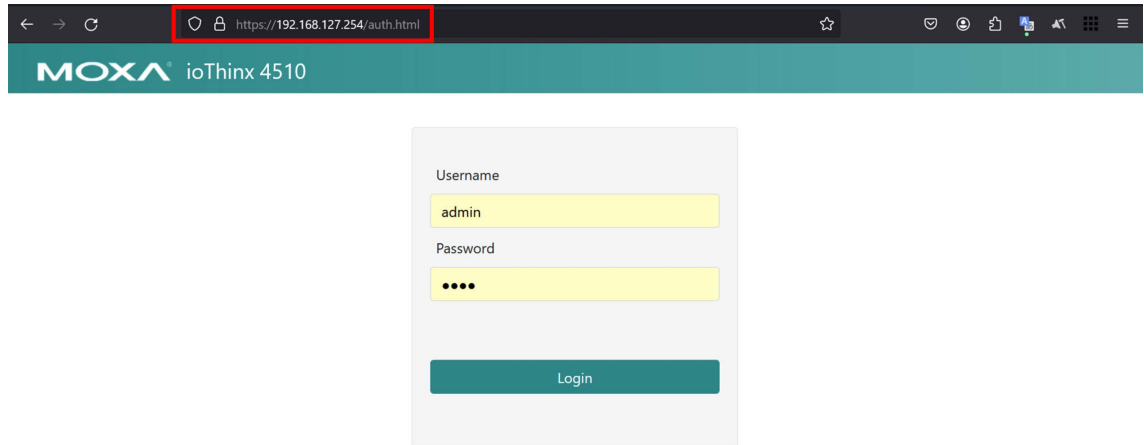

System Status and Error Code

The ioThinx 4510 provides system status and corresponding status codes for users to monitor the device's status. Users can verify in three ways.

- Web console:** You can check the current status of the ioThinx 4510 on the web console's dashboard.
- Syslog:** You can determine if there are any abnormalities by checking the **Syslog** or **Remote Syslog**.
- Protocol:** Users can use protocols, including MQTT, RestfulAPI, SNMP and Modbus TCP to monitor system status, which will be presented in the form of status codes.

The table below will list the corresponding relationship between each system status and its status code, along with explanations of the meaning of each status.

Status code	System status	Description
0x00000000	Normal	
0x00000001	Resetting to default	
0x00000002	Upgrading	
0x00000004	Booting	
0x00000008	Others	
0x00000010	External bus error. Communication watchdog will be triggered.	Northbound protocol disconnection detected.
0x00000020	Internal bus error	Internal communication is being interfered, causing the ioThinx 4510 to fail in acquiring module data correctly. Typically caused by: <ol style="list-style-type: none"> The interconnection components between modules are incorrectly installed or experiencing poor contact. External surges cause modules to malfunction or interfere with communication transmission.
0x00000080	Failed to update the configuration file	
0x00000100	Failed to update the firmware file	
0x00000200	Configuration file error. Default settings will be reloaded	
0x00000400	Module mismatch	
0x00000800	Safe mode	
0x00001000	Service warning: All IT protocols have been disabled.	Due to device limitations, the ioThinx 4510 has restricted service combinations under different scenarios. If these restrictions are violated, the device will disable all IT protocols (SNMP/ RESTful API/ MQTT) and display this status to prevent usage issues.



ATTENTION

If an Internal bus error is triggered, it may indicate that the integrity of the data could be compromised. We would recommend conducting an immediate investigation. Users can refer to the specifications provided in the manual to check if the current flowing through each terminal block connection is within the rated range, and check whether field power and system power are properly isolated. We also recommend checking for any interference or surge in the field.



NOTE

In ioThinx 4510 firmware v1.2, a safeguard mechanism has been added to the web console's service settings to prevent users from encountering service restrictions. Therefore, Error code 0x00001000 (Service warning: All IT protocols have been disabled) only exists in firmware versions prior to v1.2.